

**TA120E**

Digital Jitter Meter

**USER'S MANUAL**

---

---

Thank you for purchasing the YOKOGAWA TA120E Digital Jitter Meter. This User's Manual contains useful information about the functions, operating procedures, and handling precautions of the instrument. To ensure correct use, please read this manual thoroughly before operation. Keep this manual in a safe place for quick reference in the event a question arises. The following two manuals, including this one, are provided as manuals for the TA120E. If you purchased a TA120E with option functions, read both manuals.

Manual Title	Manual No.	Description
TA120E Digital Jitter Meter User's Manual	IM704420-01	This manual. Explains all the functions of the TA120E and their operating procedures.
TA120E Digital Jitter Meter Option Functional User's Manual	IM704420-51	Explains the option functions of the TA120E and their operating procedures.

## Notes

- The contents of this manual are subject to change without prior notice as a result of continuing improvements to the instrument's performance and functions. The figures given in this manual may differ from the actual screen.
- Every effort has been made in the preparation of this manual to ensure the accuracy of its contents. However, should you have any questions or find any errors, please contact your nearest YOKOGAWA dealer as listed on the back cover of this manual.
- Copying or reproducing all or any part of the contents of this manual without YOKOGAWA's permission is strictly prohibited.

## Trademarks

Company and product names used in this manual are trademarks or registered trademarks of their respective holders. Adobe and Acrobat are trademarks of Adobe System incorporated.

## Revisions

- First Edition February 2001

# Checking the Contents of the Package

Unpack the box and check the contents before operating the instrument. If some of the contents are not correct or missing or if there is physical damage, contact the dealer from which you purchased them.

## TA120E

Check that the model name and suffix code given on the name plate on the rear panel match those on the order.

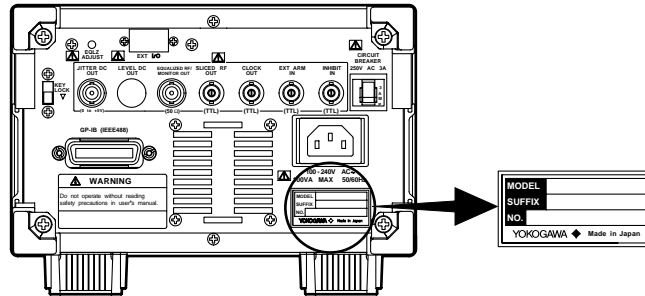

### MODEL and SUFFIX codes

Model	Suffix Code	Specifications
704420	100-240 VAC	
Power cord	-D	UL, CSA Standard Power Cord (Part No.: A1006WD) [Maximum rated voltage: 125 V; Maximum rated current: 7 A]
	-F	VDE Standard Power Cord (Part No.: A1009WD) [Maximum rated voltage: 250 V; Maximum rated current: 10 A]
	-Q	BS Standard Power Cord (Part No.: A1054WD) [Maximum rated voltage: 250 V; Maximum rated current: 10 A]
	-R	SAA Standard Power Cord (Part No.: A1024WD) [Maximum rated voltage: 240 V; Maximum rated current: 10 A]
Option	/E1	EXT I/O
	/L1	Level measurement function
	/BP1	BI-PHASE measurement function

\* For information regarding options, see the TA120E Digital Jitter Meter Option Function User's Manual (IM704420-51E).

### NO. (Instrument number)

When contacting the dealer from which you purchased the instrument, please quote the instrument number.

### Standard Accessories

The following standard accessories are supplied with the instrument:

Part Name	Part Number	Quantity	Description
1.Power cord	See the above table.	1	—
2.Rubber feet	A9088ZM	1	Two rubber feet in one set
3.EXT I/O D-sub connector	A1519JD/A1520JD	1	9 pin, male
4.User's Manual	IM704420-01E	1	This manual

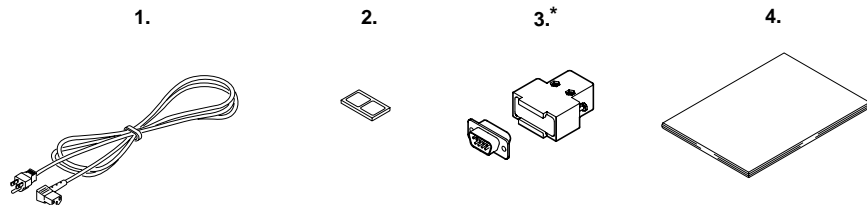

\* Included only when "EXT I/O" is specified as an option.

### Optional Accessories (Sold Separately)

The optional accessories below are available for purchase separately. For information and ordering, contact your nearest YOKOGAWA dealer.

Part Name	Model	Quantity	Notes
150-MHz probe	700998	1	Input resistance: 10 MΩ, length: 1.5 m (10:1 and 1:1 switching type)
BNC cable	366924	1	BNC-BNC, length: 1 m
BNC cable	366925	1	BNC-BNC, length: 2 m
50-Ω terminator	700976	1	—
EXT I/O D-Sub connector	A1519JD/A1520JD	1	9 pin, male
Rack mount kit	751533-E3	1	For EIA single mount
Rack mount kit	751534-E3	1	For EIA dual mount
Rack mount kit	751533-J3	1	For JIS single mount
Rack mount kit	751534-J3	1	For JIS dual mount

#### Note

We recommend you keep the packing box. The box is useful when you need to transport the instrument.

---

# Safety Precautions

This instrument is an IEC safety class I instrument (provided with terminal for protective earth grounding).

The general safety precautions described herein must be observed during all phases of operation. If the instrument is used in a manner not specified in this manual, the protection provided by the instrument may be impaired. YOKOGAWA Electric Corporation assumes no liability for the customer's failure to comply with these requirements.

## The following symbols are used on this instrument:



“Handle with care.” (To avoid injury, death of personnel or damage to the instrument, the operator must refer to the explanation in the User's Manual or Service Manual.)



Alternating current



ON (power)



OFF (power)



In-position of a bistable push control



Out-position of a bistable push control

**Make sure to comply with the safety precautions below. Not complying might result in injury or death.**

---

**WARNING**

**Power Supply**

Ensure that the source voltage matches the voltage of the power supply before turning ON the power.

**Power Cord and Plug**

To prevent the possibility of electric shock or fire, be sure to use the power cord supplied by YOKOGAWA. The main power plug must be plugged into an outlet with a protective earth terminal. Do not invalidate this protection by using an extension cord without protective earth grounding.

**Protective Grounding**

Make sure to connect the protective earth to prevent electric shock before turning ON the power. The power cord that comes with the instrument is a three-pin type power cord. Connect the power cord to a properly grounded three-pin outlet.

**Necessity of Protective Grounding**

Never cut off the internal or external protective earth wire or disconnect the wiring of the protective earth terminal. Doing so poses a potential shock hazard.

**Defect of Protective Grounding**

Do not operate the instrument if the protective earth or fuse might be defective. Make sure to check them before operation.

**Do Not Operate in an Explosive Atmosphere**

Do not operate the instrument in the presence of flammable liquids or vapors. Operation in such environments is very dangerous.

**Do Not Remove Covers**

The cover should be removed by YOKOGAWA's qualified personnel only. Opening the cover is dangerous, because some areas inside the instrument have high voltages.

**External Connection**

Securely connect the protective grounding before connecting to the item under measurement or to an external control unit.

---

---

# How to Use This Manual

## Structure of the Manual

The User's Manual consists of the following sections:

---

### Chapter 1 Explanation of Functions

Describes the functions of the instrument. Operating procedures are not given in this chapter. However, reading this chapter will help you understand the operating procedures given in the chapters that follow.

---

### Chapter 2 Names and Uses of Parts

Describes the names and uses of each part of the instrument.

---

### Chapter 3 Measurement Preparation and Common Operations

Describes preparations that are taken before making measurements such as handling precautions, how to install the instrument, how to connect to the power supply, how to turn ON/OFF the power switch, and how to connect the probe, and the procedure for entering numeric values.

---

### Chapter 4 Setting Measurement Conditions

Describes how to set the measurement conditions such as the measurement function, equalizer ON/OFF setting, trigger mode, slice level, gate, arming, inhibit, and clock signal.

---

### Chapter 5 Displaying the Measured Results

Describes how to operate the meter indication and numeric display.

---

### Chapter 6 Storing and Recalling Setup Information

Describes how to store and recall setup information from the internal memory.

---

### Chapter 7 Outputting Signals, Initializing Setup Information, and Setting Key Lock

Describes how to output signals, initialize setup information, and set key lock.

---

### Chapter 8 Communication Function

Describes the communication functions of the GP-IB interface.

---

### Chapter 9 Troubleshooting and Maintenance

Describes the possible causes of problems and their appropriate corrective measures. Describes the error codes and their appropriate corrective measures. Describes zero position adjustment of the needle, self-tests, calibration, performance tests, circuit breakers, and other information.

---

### Chapter 10 Specifications

Describes the main specifications of the instrument.

---

### Index

Index of contents.

---

## Conventions Used in this Manual

### Displayed characters

- Characters enclosed with [ ] mainly refer to characters or setting values that are displayed on the panel.
- SHIFT+key means you will press the SHIFT key to turn ON the indicator that is located above and to the left of the SHIFT key followed by the key. The action that is indicated above the corresponding key is carried out.

### Symbols

The following symbols are used in this manual:



A symbol affixed to the instrument. Indicates danger to personnel or instrument and the operator must refer to the User's Manual. The symbol is used in the User's Manual as a mark on the reference page.

### **WARNING**

Describes precautions that should be observed to prevent injury or death to the user.

### **CAUTION**

Describes precautions that should be observed to prevent minor or moderate injury, or damage to the property.

### *Note*

Provides important information for the proper operation of the instrument.

### Symbols used on pages in which operating procedures are given.

On pages that describe operating procedures in Chapter 3 through 9, the following symbols are used to distinguish the procedures from their explanations:

### **Keys**

Indicates the keys related to the operation.

### **Procedure**

Carry out the procedure according to the step numbers. The procedure is given with the premise that the user is carrying out the procedure for the first time. Depending on the operation, you may not need to carry out all the steps.

### **Explanation**

Describes the details of the settings and the restrictions that exist with the operating procedure. A detailed description of the function is not provided in this section. For a detailed description of the function, see chapter 1.



**Digital Numbers and Characters**

Because the TA120E uses a 7-segment LED display, numbers, alphabets, and operation symbols are represented using the special characters below. Some of the characters are not used.

0 → 0	A → A	K → K	U → u	^(Exponent) → ^
1 → 1	B → b	L → L	V → V	
2 → 2	C → C Lowercase c → c	M → M	W → W	
3 → 3	D → d	N → n	X → X	
4 → 4	E → E	O → o	Y → Y	
5 → 5	F → F	P → P	Z → Z	
6 → 6	G → G	Q → Q	+ → +	
7 → 7	H → H Lowercase h → h	R → r	- → -	
8 → 8	I → i	S → S	× → ×	
9 → 9	J → J	T → T	÷ → ÷	

# Contents

Checking the Contents of the Package .....	ii
Safety Precautions .....	iv
How to Use This Manual .....	vi
<b>Chapter 1 Explanation of Functions</b>	
1.1 System Configuration and Block Diagram .....	1-1
1.2 Measurement Principle .....	1-4
1.3 Measurement Functions (Measurement Items) .....	1-5
1.4 Acquisition Conditions for the Input Signal Being Measured .....	1-7
1.5 Display .....	1-12
1.6 Signal Output .....	1-13
1.7 Other Functions .....	1-14
<b>Chapter 2 Names and Uses of Parts</b>	
2.1 Front Panel .....	2-1
2.2 Rear Panel .....	2-2
<b>Chapter 3 Measurement Preparation and Common Operations</b>	
3.1 Precautions on the Use of the Instrument .....	3-1
3.2 Installing the Instrument .....	3-3
3.3 Connecting the Power Supply .....	3-6
3.4 Turning ON/OFF the Power Switch .....	3-7
3.5 Connecting the Cable or Probe .....	3-8
3.6 Phase Correcting the Probe .....	3-9
3.7 Setting the Numeric Value .....	3-11
<b>Chapter 4 Setting Measurement Conditions</b>	
4.1 Setting the Measurement Function .....	4-1
4.2 Turning ON/OFF the Equalizer .....	4-4
4.3 Setting the Trigger Mode and Slice Level .....	4-5
4.4 Setting the Gate .....	4-7
⚠ 4.5 Setting the Arming .....	4-9
⚠ 4.6 Setting Inhibit .....	4-12
4.7 Switching the Clock Signal (Applicable to D-to-C Jitter Measurements) .....	4-14
4.8 Adjusting the Phase Difference between the Data Signal and the Clock Signal (Applicable to D-to-C Jitter Measurements) .....	4-15
<b>Chapter 5 Displaying the Measured Results</b>	
5.1 Using the Analog Meter .....	5-1
5.2 Displaying the Numeric Value and Turning OFF the Numeric Display .....	5-2
<b>Chapter 6 Storing and Recalling Setup Information</b>	
6.1 Storing the Setup Information .....	6-1
6.2 Recalling the Setup Information .....	6-2

**Chapter 7 Outputting Signals, Initializing Setup Information, and Setting Key Lock**

△ 7.1 Setting the DC Output ..... 7-1  
 △ 7.2 Outputting Other Signals ..... 7-6  
 7.3 Backing Up the Setup Information ..... 7-8  
 7.4 Initializing the Setup Information ..... 7-9  
 7.5 Displaying the Version Information ..... 7-11  
 7.6 Key Lock ..... 7-12

**Chapter 8 Communication Function**

8.1 About the IEEE.488.2-1992 Standard ..... 8-1  
 8.2 GP-IB Interface Functions and Specifications ..... 8-3  
 8.3 Connecting the GP-IB Cable ..... 8-4  
 8.4 Setting the Address ..... 8-5  
 8.5 Responses to Interface Messages ..... 8-6  
 8.6 Program Format ..... 8-7  
     8.6.1 Symbols Used in the Syntax ..... 8-7  
     8.6.2 Messages ..... 8-7  
     8.6.3 Commands ..... 8-9  
     8.6.4 Responses ..... 8-11  
     8.6.5 Data ..... 8-11  
     8.6.6 Synchronization with the Controller ..... 8-13  
 8.7 Commands ..... 8-15  
     8.7.1 A List of Commands ..... 8-15  
     8.7.2 CALCulation Group ..... 8-18  
     8.7.3 COMMunicate Group ..... 8-20  
     8.7.4 DCOut Group ..... 8-21  
     8.7.5 DISPlay Group ..... 8-22  
     8.7.6 INPut Group ..... 8-23  
     8.7.7 MEASure Group ..... 8-25  
     8.7.8 MEMory Group ..... 8-26  
     8.7.9 RECall Group ..... 8-28  
     8.7.10 SAMPlE Group ..... 8-29  
     8.7.11 SSTart Group ..... 8-30  
     8.7.12 STARt Group ..... 8-30  
     8.7.13 STATus Group ..... 8-31  
     8.7.15 STORe Group ..... 8-32  
     8.7.14 STOP Group ..... 8-32  
     8.7.16 UNIT Group ..... 8-33  
     8.7.17 Common Command Group ..... 8-34  
 8.8 Status Report ..... 8-36  
     8.8.1 About the Status Report ..... 8-36  
     8.8.2 Status Byte ..... 8-37  
     8.8.3 Standard Event Register ..... 8-38  
     8.8.4 Extended Event Register ..... 8-39  
     8.8.5 Output Queue and Error Queue ..... 8-40  
 8.9 Sample Program ..... 8-41  
     8.9.1 Before Programming ..... 8-41  
     8.9.2 Sample Program Image ..... 8-41  
     8.9.3 Initialization, Error, and Functions for Execution ..... 8-42  
     8.9.4 Setting Measurement Parameters or Querying the Setting ..... 8-45  
     8.9.5 Executing Single Measurement ..... 8-49  
     8.9.6 Querying the Measurement Statistics ..... 8-50  
 8.10 ASCII Character Code ..... 8-54

**Chapter 9 Troubleshooting and Maintenance**

9.1	Troubleshooting .....	9-1
9.2	Error Code Description and Corrective Actions .....	9-2
9.3	Adjusting the Zero Position of the Needle .....	9-5
9.4	Performing a Self-Test .....	9-6
9.5	Performing Calibration (Changing the Factory Default Calibration Value) .....	9-9
⚠ 9.6	Executing the Performance Test .....	9-13
⚠ 9.7	Adjusting the Equalizer .....	9-27
⚠ 9.8	Circuit Breaker .....	9-29
9.9	Recommended Replacement Parts .....	9-30

**Chapter 10 Specifications**

10.1	Signal Input and Trigger .....	10-1
10.2	Measurement Function .....	10-2
10.3	Gate, Arming, and Inhibit .....	10-2
10.4	Display .....	10-3
10.5	Time Base .....	10-3
10.6	Input/Output on the Rear Panel .....	10-4
10.7	GP-IB Interface .....	10-5
10.8	General Specifications .....	10-6
10.9	Dimensional Drawings .....	10-7

**Index**

1

2

3

4

5

6

7

8

9

10

Index

# 1.1 System Configuration and Block Diagram

## System Configuration

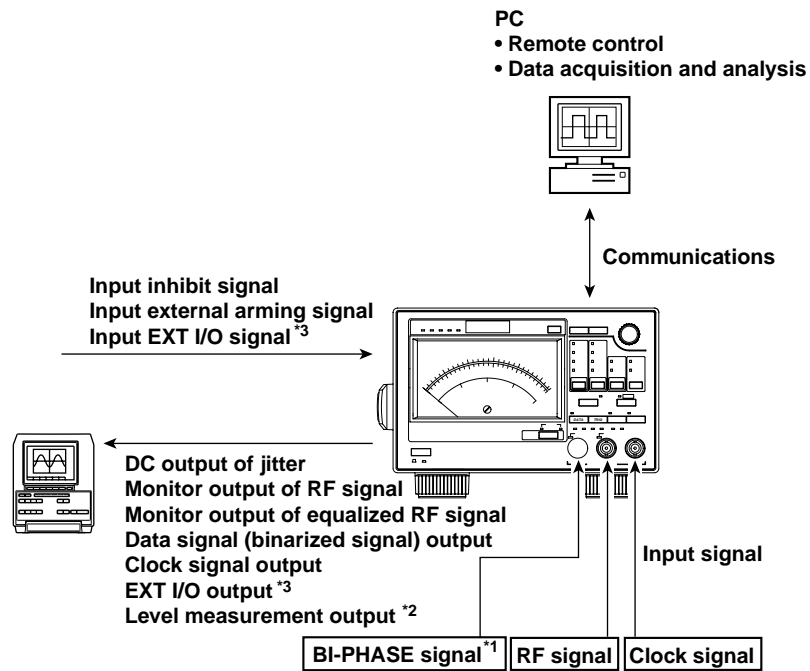

\*1 BI-PHASE measurement function option  
 \*2 Level measurement function option  
 \*3 EXT I/O option

## 1.1 System Configuration and Block Diagram

### Block Diagram

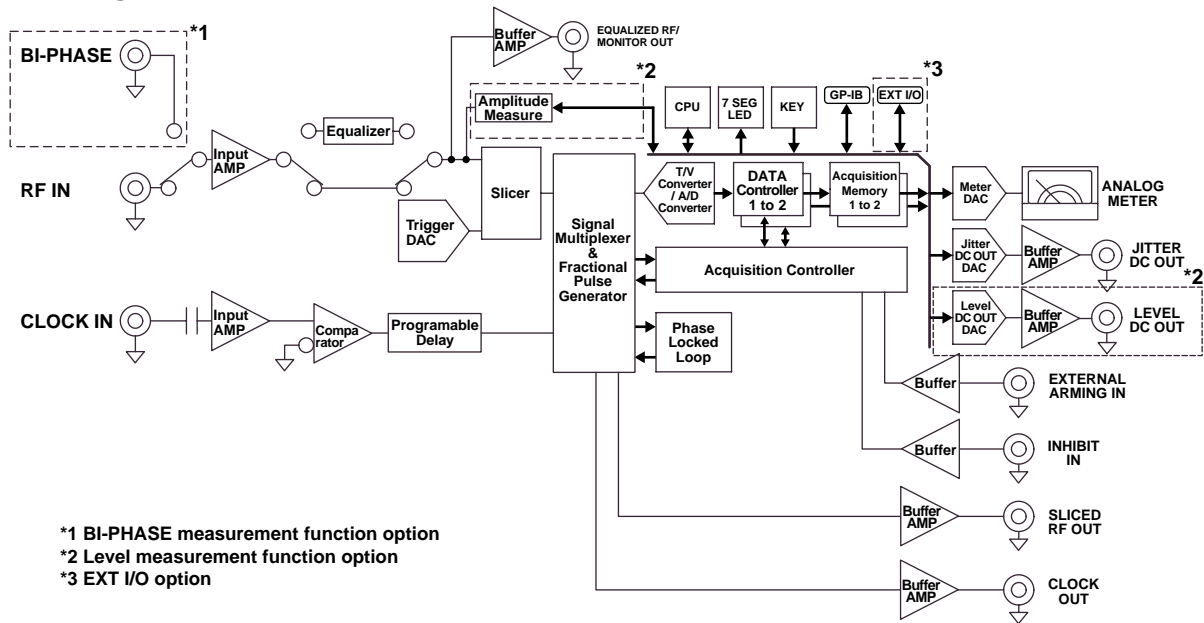

### Signal Flow

The TA120E is a jitter meter for optical disks. It measures the 3T jitter<sup>\*1</sup> and D-to-C jitter<sup>\*2</sup> of optical disks that employ the EFM method.

The amplitude of the RF signal that is input through the RF input connector (RF IN) is equalized (made into ON/OFF signals) by the equalizer. Then, the signal is converted into binary values through the slicer circuit, thus becoming a data signal. The signal multiplexer selects either the clock signal or the data signal or both according to the measurement function (measurement item) that is selected. The acquisition controller controls the acquisition of measured values according to the external arming signal (EXT ARM signal) or the inhibit signal (INHIBIT Signal). The fractional pulse generator generates fractional pulses from the signal that was selected by the signal multiplexer according to the acquisition controller's control. The pulse width of the fractional pulse is converted into voltage by the time-voltage converter (T/V converter) and then digitized using an A-to-D converter. Finally, the measured value is generated and stored in the acquisition memory.

The RF signal and clock signal are necessary in order to measure the D-to-C jitter. In some cases the clock signal is input through the clock input connector (CLOCK IN), and in other cases the clock signal is regenerated by the PLL (Phased Locked Loop) circuit based on the RF (data) signal. You can select either method. When applying a clock signal to the clock input connector, you can adjust the phase difference between the clock signal and the RF (data) signal using the programmable delay circuit. You can adjust the phase difference by observing the analog meter.

The TA120E computes the data in the acquisition memory at high-speeds and determines the jitter. The jitter that is calculated is displayed on the analog meter and the 7-segment LED display.

\*1 Pulse width jitter of the 3T data signal of a CD.

\*2 Time difference jitter between the data signal and clock signal of a DVD.

**Signal flow of the BI-PHASE function (option)<sup>\*3</sup>**

The signal applied to the BI-PHASE input terminal is binarized by the slicer and becomes a data signal. The signal multiplexer selects the polarity of the pulse width to be measured—from the rising slope to the falling slope (positive) of the data signal or from the falling slope to the rising slope (negative)—depending on the measurement function (measurement item) that you selected.

**Signal flow of the level measurement function (option)<sup>\*3</sup>**

The signal applied to the BI-PHASE input terminal or the RF input terminal is input to the amplitude measurement circuit before the slicer, and the amplitude is measured. The measured amplitude value is processed by the CPU and displayed as a numeric value on the 7-segment LED

**Signal flow of the EXT I/O (option)<sup>\*</sup>**

The condition of the input signal at each pin of the EXT I/O terminal is read by the CPU and the stored setup information is recalled. In addition, the measurement result is also output from the EXT I/O terminal

\* For details on the functions and operations, see the TA120E Digital Jitter Meter Option Function User's Manual (IM704420-51E)

## 1.2 Measurement Principle

### Pulse Width of the 3T Data Signal of a CD

The time shorter than the period of the reference clock is called the fractional time. In general, since the 3T data signal and the reference clock are not synchronized, fractional time exists both at the beginning and at the end of measurements. This instrument generates a "fractional pulse" which is a pulse signal with a period equal to the sum of the fractional time and a given time period.

If the period of the reference clock and the pulse width of the fractional pulses are taken to be  $t_0$ ,  $T_a$ , and  $T_b$ , respectively, 3T can be broken into the following terms: integer multiple of the reference clock,  $N \times t_0$ , and the pulse width of the fractional pulses,  $T_a$ ,  $T_b$ .

$$3T = N \times t_0 + (T_a - T_b)$$

This instrument converts the pulse width ( $T_a$ ,  $T_b$ ) of the fractional pulse that it generated at the beginning and end of the measurement to voltage values, which are then converted to digital values using an 8-bit A/D converter.

3T is determined by substituting the pulse width of the fractional pulses that were measured into the variables  $T_a$  and  $T_b$  of the above equation.

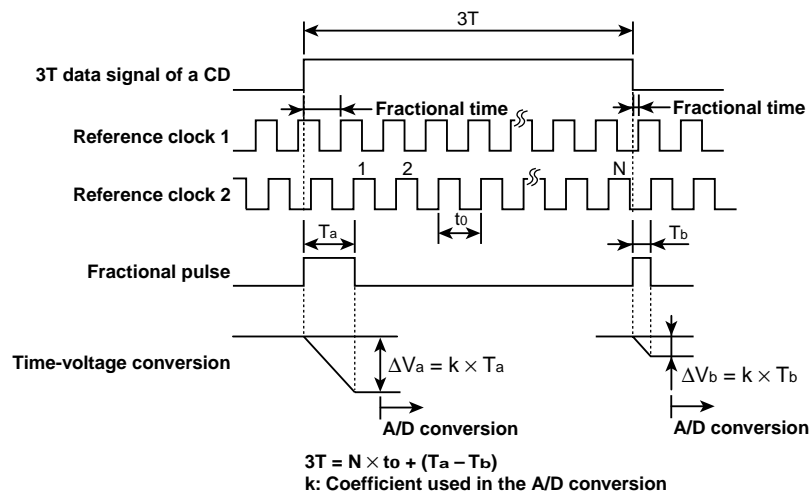

### Time Difference between the Data Signal and Clock Signal of a DVD.

Measurement is made using the same principle that is used in "Pulse Width of the 3T Data Signal of a CD" above. The following points differ:

- The reference clock is either the clock signal that is applied to the clock input connector or a clock signal that is regenerated by the PLL circuit.
- $T_c$ , the pulse width of the fractional pulse at the beginning of the measurement, is the D-to-C time difference (that is to be determined) between the data signal and the clock signal.

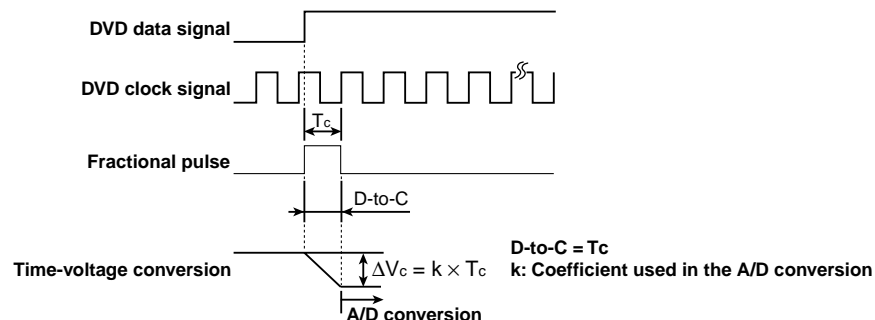



## 1.3 Measurement Functions (Measurement Items)

### 3T Jitter «See 4.1 for the operating procedure»

#### 3T measurement

Measures the pulse width from the rising edge of the slope\* to the next falling edge of the slope (positive side) or from the falling edge of the slope to the next rising edge of the slope (negative side) of the 3T data signal of a compact disk (CD).

\* Slope refers to the movement of the signal from a low level to a high level (rising edge) or from a high level to a low level (falling edge).

#### Example of pulses on the positive side

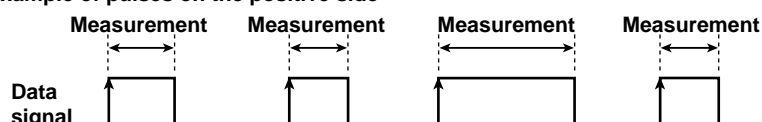

#### ×N speed setting

You can set the ×N speed of the drive being measured during 3T measurement. You can select ×1, ×4, and ×N (manual setting, where N is a value between 1.0 and 10.0).

#### Jitter $\sigma$ , jitter ratio $\sigma/T$ and average value

Determines a histogram (frequency distribution) from the measured values of multiple pulses residing in the range from 2.5T to 3.5T ( $T = 231.385$  ns), and calculates the standard deviation  $\sigma$  from the histogram. This standard deviation  $\sigma$  is the 3T jitter. The 3T jitter ratio is derived by dividing the standard deviation  $\sigma$  by the period of the CD clock signal of 231.385 ns. The time-averaged value of the measured pulse width signal is the average value AVE.

#### • 3T average value

$$AVE = \sum_{i=1}^n (X_i \times P_i)$$

#### • 3T jitter

$$\sigma = \sqrt{\sum_{i=1}^n \{(X_i - AVE)^2 \times P_i\}}$$

$n$  : Number of bins (histogram lines) of the histogram

$X_i$  : Class value of each bin

$P_i$  : Relative frequency  
(Ratio of frequency  $X_i$  of a single bin with respect to the total number of samples)

#### • 3T jitter ratio

$$\frac{\sigma}{T} \times 100(\%)$$

$T$  : The period of the CD clock signal. When the speed is 1, the period is 231.385 ns. When the speed is N, the period is 231.385 ns/N.

#### Note

You can also read statistics other than jitter, jitter ratio and average value by making inquiries using communication commands. For details, see section 8.7.2, "CALCulation Group."

**D-to-C Jitter «See 4.1 for the operating procedure»**

**Time difference measurement**

Measures the time difference between the rising (or falling) edge of the data signal to the first rising (or falling) edge of the clock signal of a digital versatile disk (DVD).

• **Example 1**

Slope of the data signal : Rising  
Slope of the clock signal : Rising

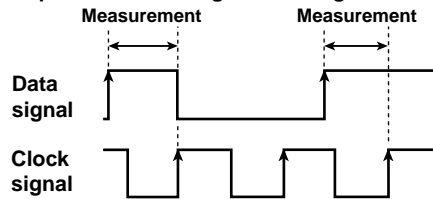

• **Example 2**

Slope of the data signal : Both rising and falling  
Slope of the clock signal : Rising edge

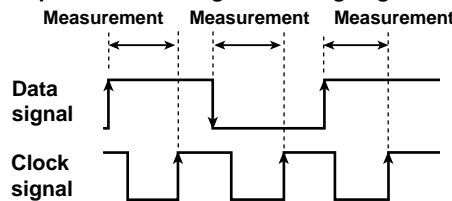

**Jitter  $\sigma$  and jitter ratio  $\sigma/T$**

Determines a histogram (frequency distribution) from multiple measured values of time difference, and calculates the standard deviation  $\sigma$  from the histogram. This standard deviation  $\sigma$  is the D-to-C jitter. The D-to-C jitter ratio is derived by dividing the standard deviation  $\sigma$  by the period  $T$  of the DVD clock signal. The time-averaged value of the measured time difference signal is the average value AVE.

• **Average value**

$$AVE = \sum_{i=1}^n (X_i \times P_i)$$

• **Jitter**

$$\sigma = \sqrt{\sum_{i=1}^n \{(X_i - AVE)^2 \times P_i\}}$$

$n$  : Number of bins (histogram lines) of the histogram  
 $X_i$  : Class value of each bin  
 $P_i$  : Relative frequency  
(Ratio of frequency  $X_i$  of a single bin with respect to the total number of samples)

• **Jitter ratio**

$$\frac{\sigma}{T} \times 100(\%)$$

$T$  : The period of the DVD clock signal.  
(Varies depending on the measured signal, because it is measured simultaneously with the data signal.)

**Note**

You can also read statistics other than jitter, jitter ratio and average value by making inquiries using communication commands. For details, see section 8.7.2, "CALCulation Group."

## 1.4 Acquisition Conditions for the Input Signal Being Measured

### Equalizing of RF Signals (Equalizer) «See 4.2 for the operating procedure»

You can equalize (compensate) the signal amplitude in the high frequency region. The signal amplitude in the high frequency region attenuates due to the frequency characteristics of the optical pickup. By passing the RF signal that is applied to the RF input connector through the equalizer, we can obtain a signal that has frequency characteristics that do not attenuate up to the high frequency region (better frequency characteristics than the optical pickup).

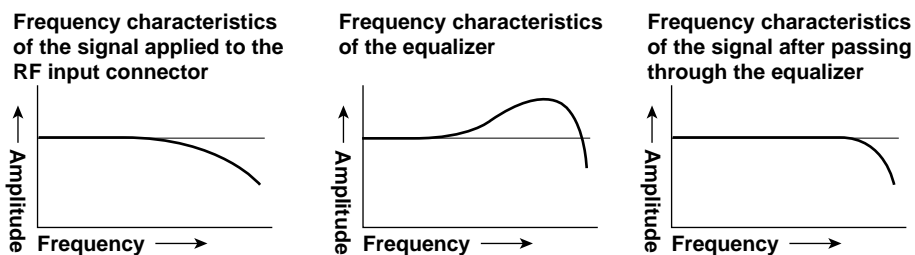

### Binarization of the RF Signal

The binarized data signal of the RF signal is the signal used to measure the pulse width and time difference. Using the slicer of the TA120E, the RF signal is binarized by setting the portion of the signal that is greater than the given slice level\* to the positive side and the portion that is less than the slice level to the negative side.

\* The slice level changes depending on the trigger mode setting. For setting the trigger mode and slice level, see "Trigger Level and Slice Level" described later.

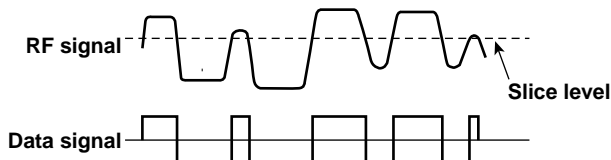

#### Auto slice

To compensate for asymmetric signal waveforms specific to the CD or DVD, the slice level can be automatically detected so that the time ratio between the positive and negative sides of the RF signal is 50%. The RF signal is binarized using the detected slice level. The auto slice function operates when the trigger mode is set to "auto mode" or "auto + manual mode."

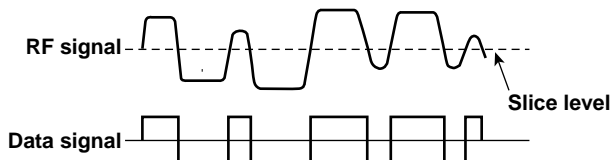

## 1.4 Acquisition Conditions for the Input Signal Being Measured

### Trigger Mode and Slice Level «See 4.3 for the operating procedure»

When measuring the pulse width or time difference of a single pulse, you can select the level of the data signal at which to make the measurement (activate the trigger). Slice level refers to the level at which the RF signal is binarized. The trigger is activated at this slice level.

#### Auto mode

The RF signal is binarized using the slice level that is detected by the auto slice function.

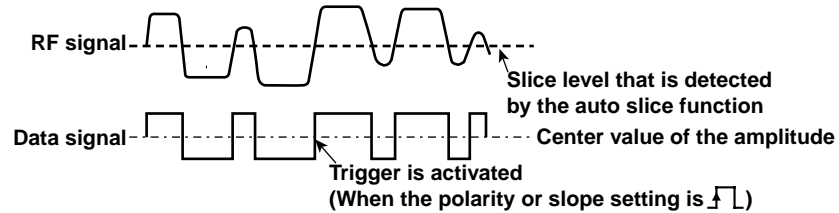

#### Manual mode

The RF signal is binarized using the slice level that is specified in the range from  $-5\text{ V}$  to  $5\text{ V}$  ( $-1\text{ V}$  to  $1\text{ V}$  when the equalizer is in operation).

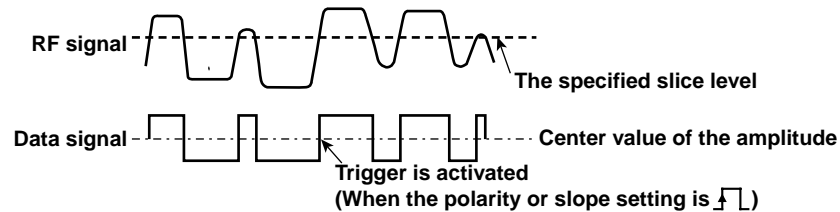

#### Auto + manual mode

The RF signal is binarized using the slice level obtained by superimposing the offset level that is specified in the range from  $-1\text{ V}$  to  $1\text{ V}$  on the slice level that is detected by the auto slice function. This offset level is set separately from the slice level of the manual mode described above.

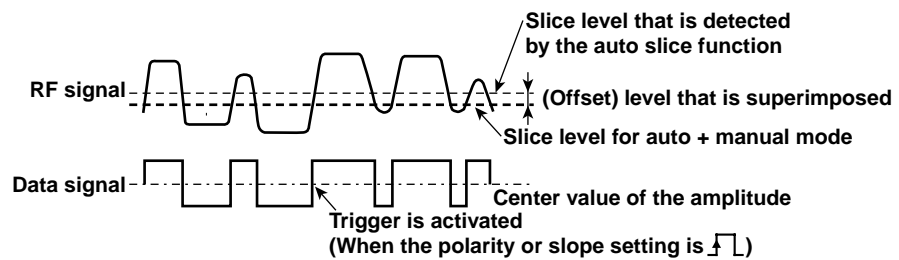

**Gate «See 4.4 for the operating procedure»**

You can set the time (gate time) during which the measured values of pulse width and time difference are stored in the acquisition memory. You can also set a gate by specifying the number (number of events) of measured values to be acquired.

**Event gate**

$10^5$  measured values are stored in the acquisition memory. Of those values, the ones that are in the measurement range, as determined by the measurement function, are used to derive the measurement result (jitter). You cannot change the number of events.

**Time gate**

You can select from 0.1 s, 0.5 s, and manual (1 ms to 1000 ms).

**Arming «See 4.5 for the operating procedure»**

Arming refers to the cue used to start the measurement. In contrast to trigger which refers to the cue used to measure the pulse width or time difference of each pulse, arming refers to the starting point of the measurement of a set of pulse widths or time differences used to derive the jitter.

**Auto arming (internal arming)**

The internal signal of the TA120E is the arming source. Arming is the cue used to start the first measurement (the first trigger).

**External arming**

Arming is activated when an external signal (arming source) is applied to the external arming input connector. You can also select whether the rising or falling edge is used to activate the arming.

**Arming delay**

When using external arming, you can delay the start of the measurement by a given amount of time (delay time) after arming occurs. You can set the delay time in the range from 0 ms to 1000 ms.

## 1.4 Acquisition Conditions for the Input Signal Being Measured

### Inhibit «See 4.6 for the operating procedure»

You can inhibit measurements by applying an external signal to the INHIBIT input connector. This is possible even while the gate is open or during measurement after arming activation. You can also select which polarity of the signal, positive or negative, is used to inhibit measurements.

The relation between the inhibit signal, gating, and arming for a positive 3T jitter measurement is indicated below.

#### Relation between the inhibit signal and gating

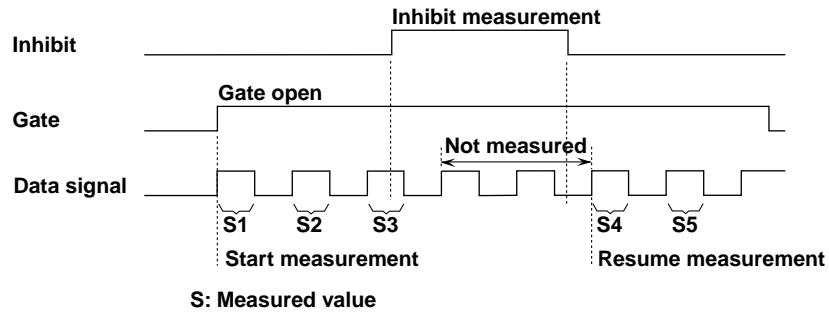

#### Relation between the inhibit signal, gating, and external arming

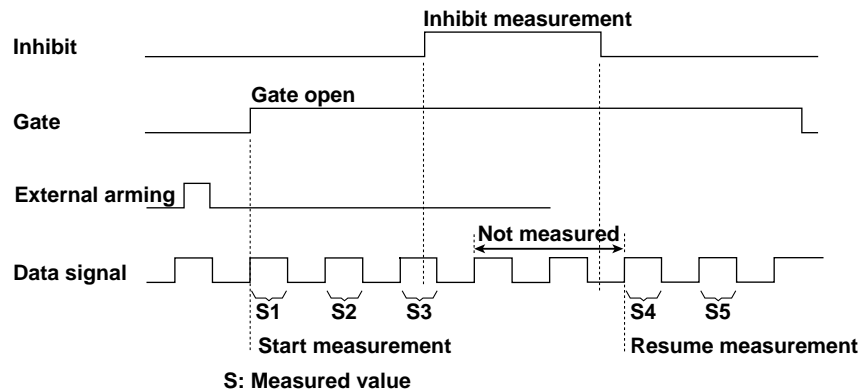

#### Relation between the inhibit signal, gating, external arming, and arming delay

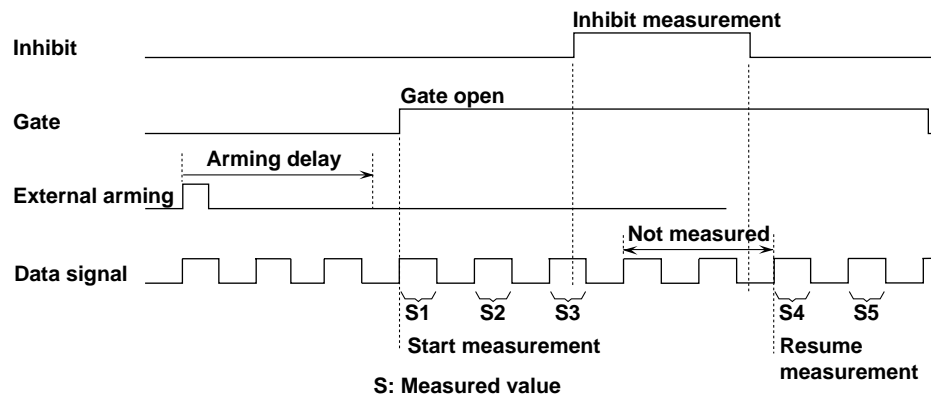

## Clock Signal Input

### **Regenerating the clock signal «See 4.7 for the operating procedure»**

The clock signal that is necessary in measuring the D-to-C jitter can be regenerated by the PLL circuit of the TA120E. You can also measure the time difference by applying a DVD clock signal to the clock input connector instead of regenerating the clock signal using the PLL circuit.

### **Selecting the slope «See 4.1 for the operating procedure»**

When using the clock signal that is applied to the clock input connector for measuring the D-to-C jitter, you can select on which slope (rising edge or falling edge) of the clock signal to make the measurement.

### **Adjusting the phase difference «See 4.8 for the operating procedure»**

When using the clock signal that is applied to the clock input connector for measuring the D-to-C jitter, you can adjust the phase difference between the data signal and the clock signal. You can adjust the phase difference within the range 0 ns to 40 ns.

---

## 1.5 Display

### Meter Display «See 5.1 for the operating procedure»

The TA120E indicates the jitter ratio, phase difference, etc. on the analog meter.

#### Jitter ratio indication

The jitter ratio of the selected measurement function is indicated on the analog meter. You can select the 10% scale or the 20% scale. The indication range is 0% to 11% for the 10% scale and 0% to 22% for the 20% scale.

#### Phase difference indication <<See 4.8 for the operating procedure>>

The phase difference between the data signal and the clock signal applied to the clock input connector during D-to-C jitter measurement is indicated on the analog meter. The indication range is from 0 deg to 360 deg.

### Numeric Display «See 5.2 for the operating procedure»

The TA120E displays numeric values and characters such as the jitter, jitter ratio, specified value, error code, and firmware version on the 7-segment LED display.

#### Numeric display of jitter/jitter ratio and average value

The jitter or jitter ratio of the selected measurement function or the average value that is derived in the process of determining the jitter and jitter ratio is displayed using a numeric value. You can switch the display between jitter, jitter ratio, and average value.

#### Turning OFF the jitter, jitter ratio and average value numeric display

If it is undesirable to view the changes in the numeric display of the jitter, jitter ratio or average value, the characters "d-oFF" can be displayed instead of these values.

#### Specified value display

When specifying values for setting up the TA120E such as manual setting of  $\times N$  speed, manual setting of gate time, arming delay setting, slice level setting when the trigger mode is set to manual mode or auto + manual mode, phase adjustment setting, and address setting for GP-IB communications, the corresponding specified value is displayed.

#### Error code display

An error code is displayed when an error occurs during operation or measurement. For details on the error codes and information, see section 9.2.

#### Version display

The firmware version (ROM version) of the TA120E can be displayed. (section 7.5)  
The firmware version is also displayed when entering the maintenance mode (section 9.4) of the TA120E.



## 1.6 Signal Output

### DC Output of Jitter «See 7.1 for the operating procedure»

The jitter ratio of the selected measurement function can be converted to DC voltage (0 V to 5 V) and output from the jitter DC output connector on the rear panel. You can also change the jitter ratio that corresponds to 0 V and 5 V.

#### Jitter ratio determination

You can specify the determination level in terms of a jitter ratio and output 5 VDC when the data signal is less than or equal to the determination level and 0 VDC when it is greater than the determination level.

#### DC output filter

This function takes a moving average of the measured jitter. When the DC output fluctuates due to instability in the measured jitter, this function suppresses the degree of fluctuation. You can set the number of measured values (average coefficient) to be averaged in the range from 1 to 10.

#### When the average coefficient is set to 5

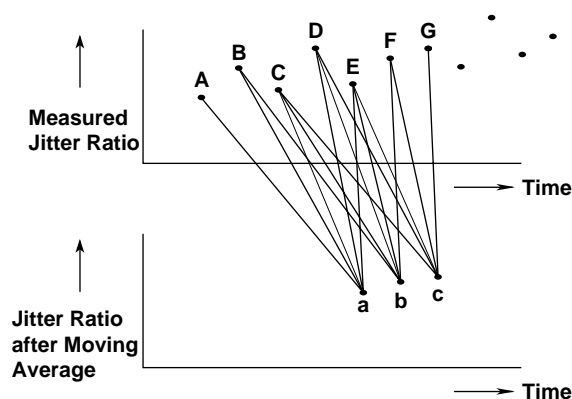

### Monitor Output of RF Signal/Monitor Output of Equalized RF Signal «See 7.2 for the operating procedure»

You can output the RF signal that is applied to the RF input connector directly to the monitor output on the rear panel. If the equalizer is activated, the equalized RF signal is output.

### Data Signal Output «See 7.2 for operating procedure»

You can output the data signal obtained by slicing and binarizing the RF signal from the data signal output connector on the rear panel at TTL levels.

### Clock Signal Output «See 7.2 for operating procedure»

You can output the clock signal that is applied to the clock input connector or the clock signal that is regenerated by the PLL circuit from the clock signal output connector on the rear panel at TTL levels.

---

## 1.7 Other Functions

### **Communications (GP-IB) «See chapter 8 for the operating procedure»**

The GP-IB Interface comes standard with the TA120E. You can output the jitter or jitter ratio of the selected measurement function to a PC or control the TA120E from an external controller.

### **Storing and Recalling Setup Information «See chapter 6 for the operating procedure»**

Up to seven sets of setup information can be stored in the internal non-volatile memory. You can also recall the stored setup information and change the settings.

### **Backing Up Setup Information «See 7.3 for the operating procedure»**

The setup information is stored using a lithium battery. When the power switch is turned ON, the TA120E starts the measurement using the settings that existed immediately before the power switch was turned OFF. If the setup information can no longer be stored due to a dead lithium battery, the TA120E is reset to the factory default settings.

### **Initializing Setup Information «See 7.4 for the operating procedure»**

The TA120E has the following two methods of initializing the setup information.

- Initialization to factory default settings
- Initialization of the information excluding the following settings:
  - Communication address
  - Stored information in the internal memory

### **Version Display «See 7.5 for the operating procedure»**

The firmware version (ROM version) of the TA120E can be displayed.

### **Key Lock «See 7.6 for the operating procedure»**

You can disable the front panel key operation.

### **Adjusting the Zero Position of the Needle «See 9.3 for the operating procedure»**

You can adjust the zero position of the needle.

### **Self-Test «See 9.4 for the operating procedure»**

If you are in doubt as to whether the instrument has malfunctioned, you can run a self-test before contacting a YOKOGAWA dealer. You can check things such as the keys, rotary knob, indicator, meter, and board.

### **Calibration «See 9.5 for the operating procedure»**

Using the internal calibration signal, the offset voltage of the input amplifier and the conversion coefficient of the time-voltage converter can be calibrated.

### **Detection of a Cooling Fan Malfunction**

The condition of the cooling fan is monitored at all times. If the fan stops, error code 906 is shown on the display. In this case, immediately turn OFF the power. If you continue to use the instrument, a warning is given approximately every 10 s by displaying the error code until the cooling fan recovers.

# 2.1 Front Panel

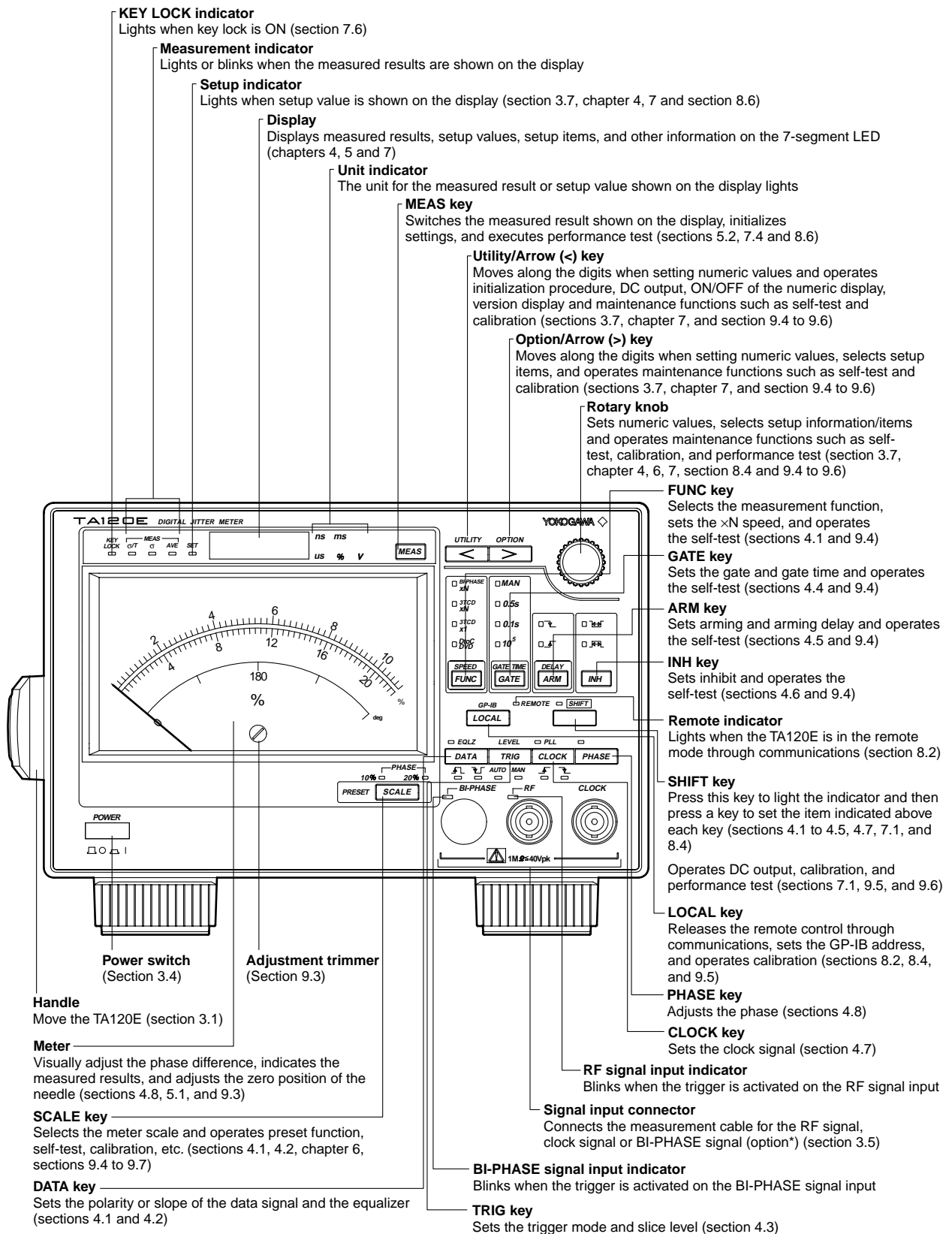

\* See the TA120E Digital Jitter Meter Option Function User's Manual (IM704420-51E).

## 2.2 Rear Panel

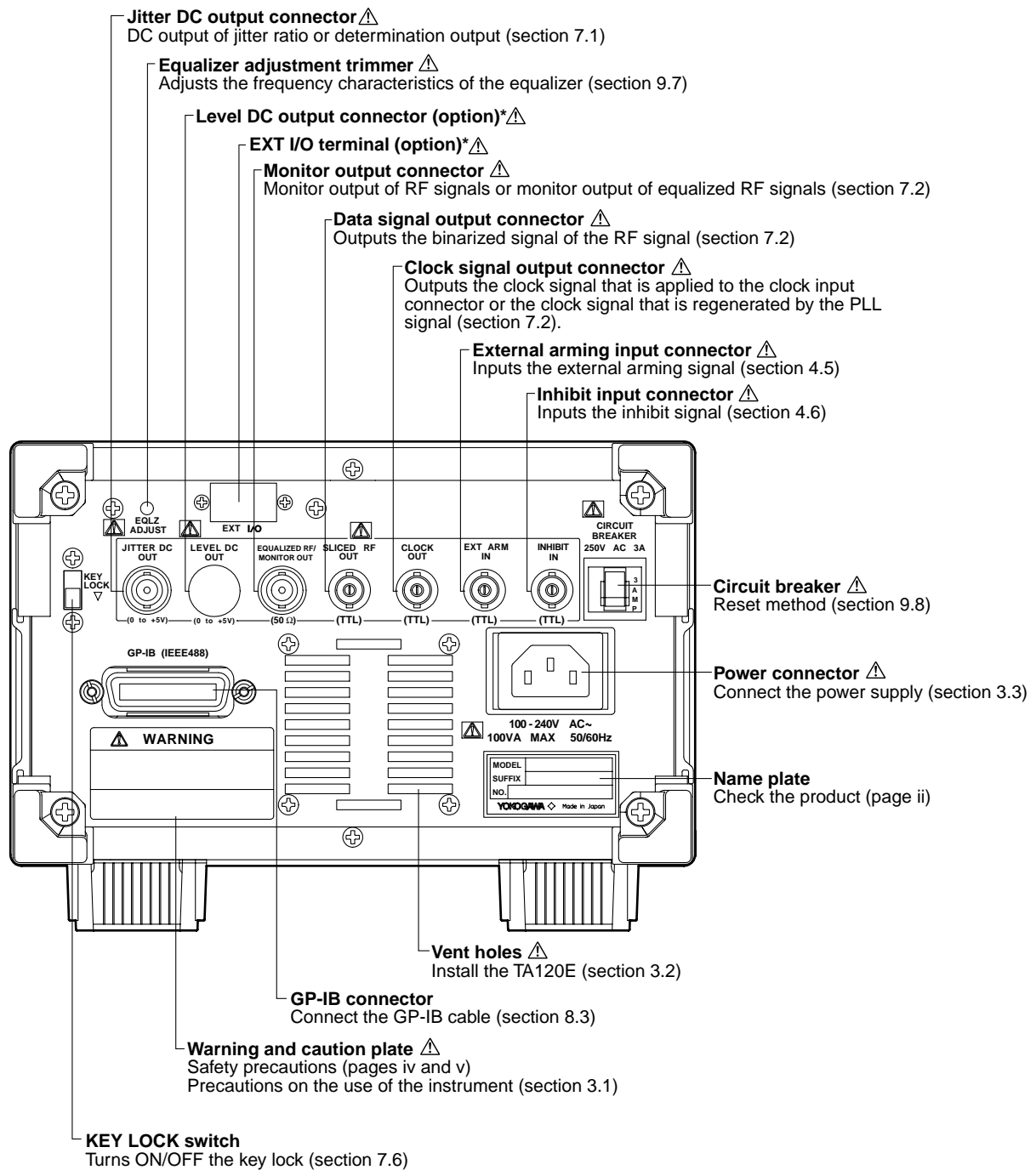

\* See the TA120E Digital Jitter Meter Option Function User's Manual (IM704420-51E).

## 3.1 Precautions on the Use of the Instrument

### Safety Precautions

#### Safety Precautions

When using the instrument for the first time, make sure to read the "Safety Precautions" given on pages iv and v.

#### Do not remove the cover

Do not remove the cover from the instrument. Some sections inside the instrument have high voltages that are extremely dangerous. For internal inspection or adjustment, contact your nearest YOKOGAWA dealer as listed on the back cover of this manual.

#### Abnormal behavior

Stop using the instrument if there are any symptoms of trouble such as strange odors or smoke coming from the instrument. If these symptoms occur, immediately turn OFF the power and unplug the power cord. Contact your nearest YOKOGAWA dealer as listed on the back cover of this manual.

#### When the cooling fan stops

If error code 906 appears on the display, the cooling fan is stopped. Immediately turn OFF the power switch. From the rear panel, check for and remove any foreign object that may be obstructing the cooling fan. If error message 906 appears when you turn ON the power switch again, it is probably a malfunction. Contact your nearest YOKOGAWA dealer as listed on the back cover of this manual.

#### Power cord

Nothing should be placed on top of the power cord. The power cord should also be kept away from any heat sources. When unplugging the power cord from the outlet, never pull by the cord itself. Always hold and pull by the plug. If the power cord is damaged, check the part number indicated on page ii and purchase a replacement.

### 3.1 Precautions on the Use of the Instrument

---

#### General Handling Precautions

**Do not place objects on top of the instrument**

Never place any objects containing water on top of the instrument. Water spills can lead to malfunction.

**Do not apply shock or vibration to the instrument**

Shock or vibration can lead to malfunction. Take extra caution because the built-in meter is sensitive to vibration and shock. In addition, applying shock to the input terminal or the connected cable can cause electrical noise to enter the instrument.

**Do not bring charged objects near the instrument**

Do not bring charged objects near the input connector. This can damage the internal circuitry.

**When not using the instrument for a long period of time**

Turn OFF the power switch and remove the power cord from the outlet.

**When carrying the instrument**

First, remove the power cord and connection cables. The weight of the instrument is approximately 5 kg. To carry the instrument, use the handle as shown in the figure below, and move it carefully.

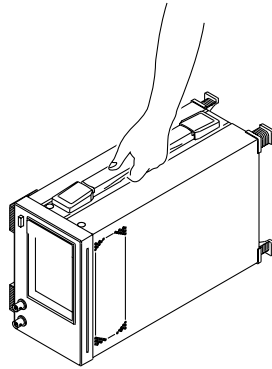

**When wiping off dirt**

When wiping off dirt from the case or operation panel, turn OFF the power switch and remove the power cord from the outlet. Then, gently wipe with a soft dry clean cloth. Do not use volatile chemicals as this may cause discoloring and deformation.

## 3.2 Installing the Instrument



### WARNING

To avoid the possibility of fire, never use the instrument with the rear panel facing down. There are vent holes for the cooling fan on the rear panel. Placing the instrument with the rear panel down can cause a fire when the instrument malfunctions. If you must use the instrument with the rear panel down, place a metal plate or a flame-resistant barrier (grade UL94V-1 or higher) beneath the instrument.

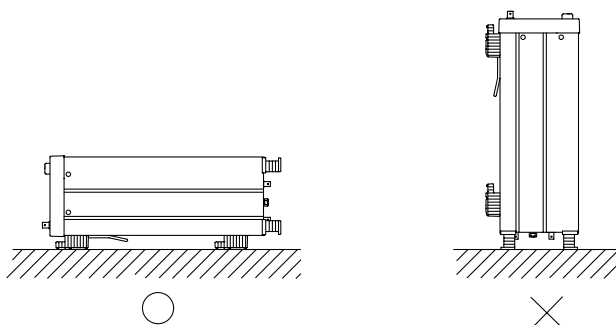

### Note

The specification of the meter presumes that the TA120E is installed horizontally and that the meter is in the vertical position. The specifications of the meter cannot be satisfied when the instrument is installed with the rear panel down.

### Installation Condition

Install the instrument in a place that meets the following conditions:

#### Flat and even surface

Install the instrument in a stable horizontal place. Accurate measurements may be hindered when the instrument is used in an unstable place or tilted position.

#### Well-ventilated location

There are vent holes on the topside of the instrument. In addition, there are vent holes for the cooling fan on the rear panel. To prevent internal overheating, allow for enough space around the instrument (see the figure below) and do not block the vent holes.

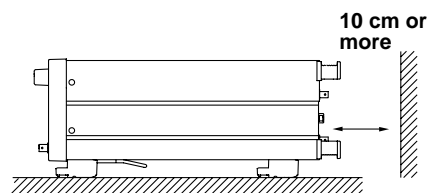
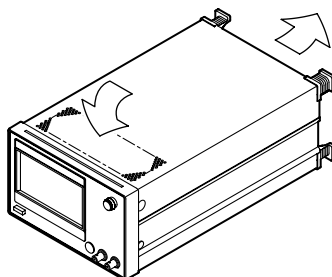

## 3.2 Installing the Instrument

---

### Ambient temperature and humidity

Use the instrument in the following environment.

- Ambient temperature: 5°C to 40°C  
However, in order to obtain highly accurate measurements, operate the instrument in the  $23 \pm 5^\circ\text{C}$  temperature range.
- Ambient humidity: 20% to 80% RH  
No condensation should be present. However, in order to obtain highly accurate measurements, operate the instrument in the  $50 \pm 10\%$  RH range.

### Note

---

Condensation may occur if the instrument is moved to another place where the ambient temperature is higher, or if the temperature changes rapidly. In this case, let the instrument adjust to the new environment for at least an hour before using it.

---

### Do not install the instrument in the following places:

- In direct sunlight or near heat sources.
- Where an excessive amount of soot, steam, dust, or corrosive gas is present.
- Near strong magnetic field sources.
- Near high voltage equipment or power lines.
- Where the level of mechanical vibration is high.
- In an unstable location.

## Storage Location

When storing the TA120E, avoid the following locations:

- A place with a relative humidity of 80% or more.
- In direct sunlight.
- A hot place with a temperature of 60°C or more.
- Near a high humidity or heat may source.
- Where mechanical vibration is high.
- A place with corrosive gases or flammable gases.
- A place with a lot of dust, trash, salt, or iron powder.
- A place where water, oil, or chemicals splash.

We strongly recommend you store the TA120E in an environment with a temperature between 5°C and 40°C and a relative humidity between 20% to 80% RH.



## Installation Position

### Desk top

Install the instrument horizontally.

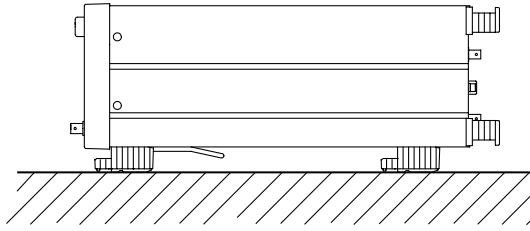

### Note

It is possible to install the TA120E with the stand in the upright position. However, note that the specification of the meter presumes that the TA120E is installed horizontally and that the meter is in the vertical position. When using the stand, pull the stand forward until it locks (perpendicular to the bottom surface of the instrument). If you are installing the instrument on a slippery surface, attach the rubber feet (two pieces, included in the package) to the hind feet. If you are not using the stand, return it to the original position while pressing the leg section of the stand inward.

### Rack mount

When rack mounting the TA120E, use the rack mount kit that is sold separately. For the procedure on attaching the TA120E to a rack, see the User's Manual included in the rack mount kit.

Part Name	Model	Notes
Rack mount kit	751533-E3	For EIA single mount
Rack mount kit	751534-E3	For EIA dual mount
Rack mount kit	751533-J3	For JIS single mount
Rack mount kit	751534-J3	For JIS dual mount

## 3.3 Connecting the Power Supply

### Before Connecting the Power Supply

To prevent the possibility of electric shock and damage to the instrument, follow the warnings below.



#### WARNING

- Ensure that the supply voltage matches the rated supply voltage of the instrument before connecting the power cord.
- Check that the power switch is turned OFF before connecting the power cord.
- To prevent the possibility of electric shock or fire, be sure to use the power cord supplied by YOKOGAWA.
- Make sure to perform protective grounding to prevent the possibility of electric shock. Connect the power cord to a three-pin power outlet with a protective earth terminal.
- Do not use an extension cord without protective earth ground. Doing so will invalidate the protection.

### Connecting the Power Cord

1. Check that the power switch on the front panel of the instrument is turned OFF.
2. Connect the power cord plug to the power connector on the rear panel. (Use the power cord that came with the package.)
3. Connect the plug on the other end of the power cord to the outlet that meets the conditions below. The AC outlet must be of a three-pin type with a protective earth ground terminal.

Item	Specifications
Rated supply voltage	100 V to 240 VAC
Permitted supply voltage range	90 V to 264 VAC
Rated supply voltage frequency	50/60 Hz
Permitted supply voltage frequency range	48 Hz to 63 Hz
Maximum power consumption	100 VA

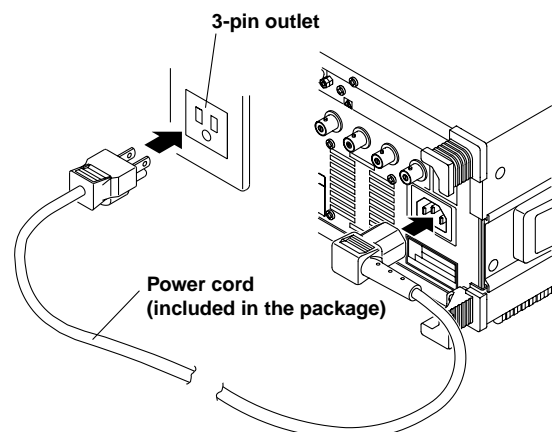

## 3.4 Turning ON/OFF the Power Switch

### Things to Check before Turning ON the Power

- Is the instrument properly installed? → Section 3.2, “Installing the Instrument”
- Is the power cord properly connected? → Section 3.3, “Connecting the Power Supply”

### Location of the Power Switch and ON/OFF Operation

The power switch is located at the lower left corner of the front panel. The power switch is a push button. Press once to turn it “ON” and press again to turn it “OFF.”

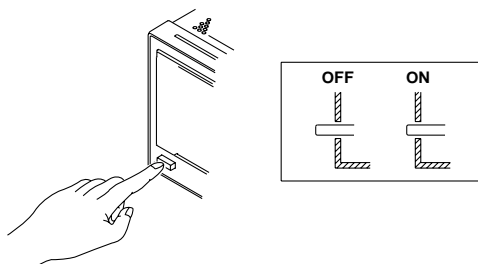

### Power Up Operation

When the power switch is turned ON, “[TA120E→704420]” appears on the 7-segment LED display and the test program automatically starts. When the test program completes normally, “[PASS]” is shown on the display and the TA120E is ready to make measurements. The setup conditions are restored to the ones that existed immediately before the power switch was turned OFF.

#### Note

If the TA120E does not operate as described above when the power switch is turned ON, turn OFF the power switch and check the following points:

- Is the power cord securely connected?
- Is the correct voltage coming to the power outlet? → See section 3.3.
- Is the circuit breaker ON? → See section 9.8.
- You can initialize the settings of the TA120E. There are two methods of initialization. See section 7.4.
  - Turn ON the power switch while pressing the MEAS key → the setup information is initialized to the factory default condition.
  - Press the SHIFT+<(UTILITY) key and select [init] → the setup information excluding the communication address and setup information stored to the memory is initialized.

If the instrument still fails to power up when the power switch is turned ON after checking these points, it is probably a malfunction. Please contact your nearest YOKOGAWA dealer as listed on the back cover of this manual for repairs.

### To Make Accurate Measurements

Under the installation condition indicated in section 3.2, allow the instrument to warm up for at least 30 minutes after the power switch is turned ON before starting the use of the instrument.

### Shutdown Operation

The setup information that exists immediately before the power switch is turned OFF is stored. This holds true also when the power cord becomes unplugged. Note that the measured results are not stored.

#### Note

The lithium battery that is used to store the setup information has a limited life span. When the voltage level of the lithium battery drops below a given level, error code 909 appears on the display when the power switch is turned ON. If the error code appears frequently, the lithium battery must be replaced quickly. The user cannot replace the battery. Contact your nearest YOKOGAWA dealer as listed on the back cover of this manual. For the life span of the battery, see section 9.9.

## 3.5 Connecting the Cable or Probe

### Position of the Signal Input Connector

The signal input connector is located at the lower right section of the front panel. Connect a cable or a probe with a BNC connector.

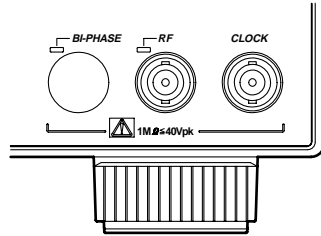

### Signal Input Specifications

Item	Specifications
Connector type	BNC
Number of channels	2 (1 RF input connector and 1 clock input connector)
Input impedance	1 MΩ, 35 pF (typical value*)
Maximum input voltage	DC ≤ frequency of the input signal ≤ 100 kHz: 40 V (DC+ACpeak) 100 kHz ≤ frequency of the input signal ≤ 100 MHz: {3.5/f + 5} V (DC+ACpeak), where f is a frequency in MHz.
Ground	Connect to the case ground

\* The typical value is a representative or standard value. It is not a warranted value.



### CAUTION

Do not apply a voltage that exceeds the maximum input voltage to the input connector. This may cause damage to the input section.

### Note

When connecting the probe for the first time, perform phase correction of the probe according to the description given in section 3.6. Failure to do so will cause unstable gain across different frequencies, thereby preventing correct measurement. Phase correction of the probe must be performed when the probe changes or the TA120E changes.

## 3.6 Phase Correcting the Probe

### Items Required

The following items are required:

#### Compensation signal

Frequency	Approx. 1 kHz
Voltage (waveform amplitude)	Approx. 1 V <sub>P-P</sub>
Waveform type	Rectangular wave
Output impedance	Approx. 1 MΩ
Recommended signal	CAL signal of Digital Oscilloscope DL1540 (YOKOGAWA)

#### Waveform monitor

Frequency characteristics	DC to 100 MHz (−3 dB point)
Input coupling	DC
Input impedance	Connect a 50-Ω terminator to the input connector of the waveform monitor.
Recommended instrument	Digital Oscilloscope DL1540 (YOKOGAWA) and a 50-Ω terminator (700976, YOKOGAWA)

The connection procedure and operation when the recommended signal is connected to the recommended instruments are described below.

### Connecting the Instrument



#### CAUTION

- Do not apply a voltage that exceeds the maximum input voltage to the input connector. This may cause damage to the input section.
- Do not short the CAL signal output terminal of the DL1540 or the monitor output connector of the TA120E. Do not apply external voltage to the monitor output connector. This may cause damage to the internal circuitry.

Check that the TA120E and DL1540 are turned OFF and connect them as shown in the figure.

1. Using a BNC cable, connect the monitor output connector on the rear panel of the TA120E and the signal input connector of the DL1540.
2. Connect the BNC end of the probe that is to be phase corrected to the RF input connector on the front panel of the TA120E.
3. Connect the other end of the probe to the CAL signal output terminal of the DL1540 and the ground wire to the functional ground terminal.

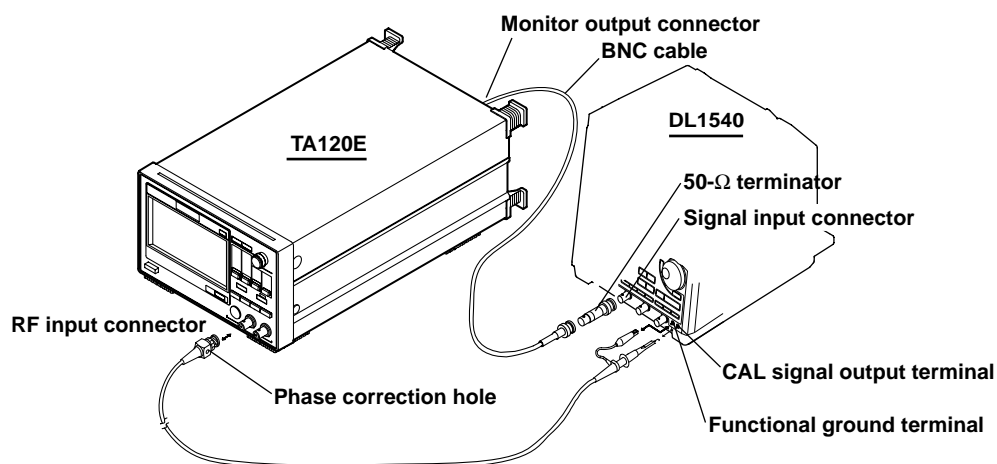

### 3.6 Phase Correcting the Probe

#### Procedure

1. Turn ON the TA120E and DL1540.
2. Turn OFF the equalizer of the TA120E (see section 4.2).
3. Set the waveform acquisition conditions of the DL1540 so that approximately two periods of the waveform can be viewed in its entirety. For the procedure, see the DL1540 User's Manual.
4. Insert a flat-head screwdriver to the phase correction hole of the probe and turn the variable capacitor to make the displayed waveform on the waveform monitor a correct rectangular wave (see explanation).

#### Explanation

##### The necessity of phase correction of the probe

If the input capacity of the probe is not within the adequate range, the gain across different frequencies will not be uniform. Consequently, a correct waveform cannot be input to the measurement circuit of the TA120E. The input capacity of each probe is not necessarily all the same. Therefore, the probe has a variable capacitor (trimmer) that allows the input capacity to be adjusted. This adjustment is called phase correction.

When using the probe for the first time, make sure to perform phase correction. The appropriate input capacity varies depending on the input connector of the instrument. Therefore, phase correction must also be performed when the connected instrument is changed.

##### Compensation signal

Waveform type	Rectangular wave
Frequency	Approx. 1 kHz
Voltage	Approx. 1 V <sub>P-P</sub>

##### Differences in the waveform due to the phase correction of the probe

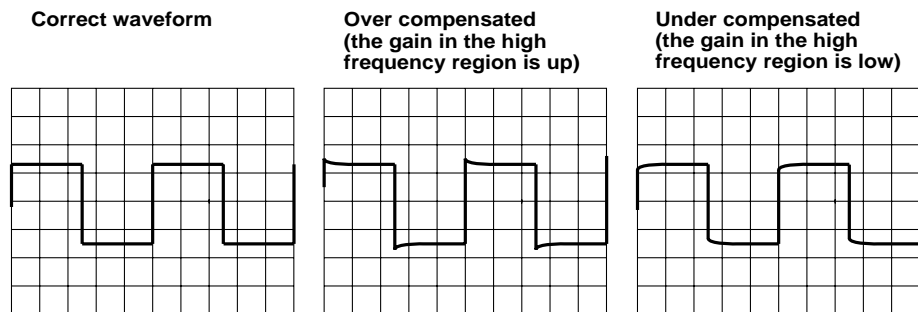

## 3.7 Setting the Numeric Value

### Keys

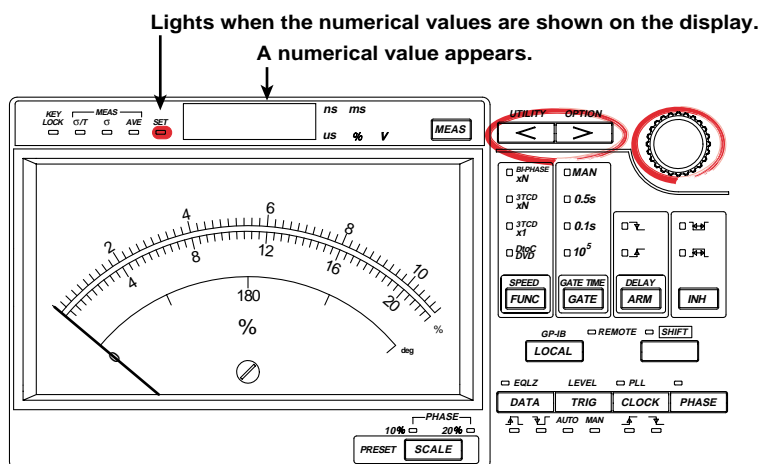

### Procedure

You can set numeric values (setup values) when the SET indicator is ON.

1. Check that the SET indicator is ON.
2. Check that a numeric value is shown on the display.
3. Press the arrow keys (< or >) to select the digit you wish to change. The value at the selected digit blinks.
4. Turn the rotary knob to set the value within the range of each item. As the value of the selected digit is increased, the next higher digit is also increased at appropriate times. In contrast, as the value of the selected digit is decreased, the next lower digit is also decreased at appropriate times.

### Explanation

You can set the numeric value within the range of each item. You can confirm that the TA120E is ready to accept numeric values when the SET indicator is ON and a single digit of the numeric value on the display is blinking.

### Note

You can reset the specified numeric value to the initial value (factory default setting). For details, see section 7.4.

# 4.1 Setting the Measurement Function

«For a functional description, see section 1.3.»

## Keys

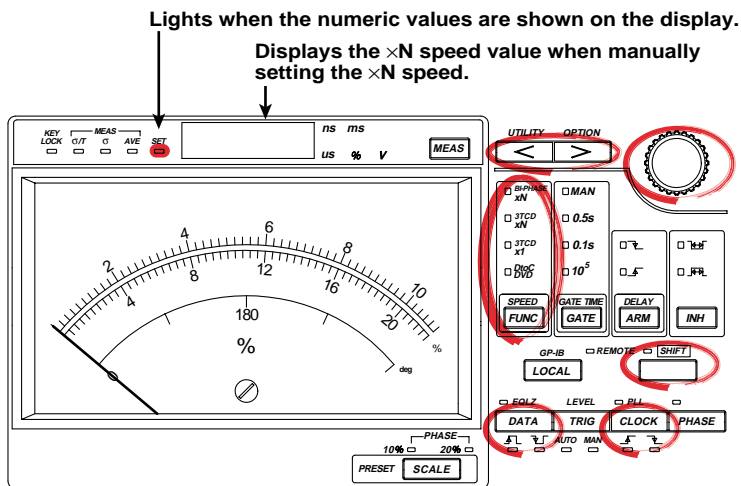

## Procedure

### Setting the measurement function to 3T jitter

1. Press the FUNC key to select [x1] or [xN]. The indicator of the selected item lights.  
If you selected [x1], proceed to step 4.  
If you selected [xN], proceed to step 2.

- **Manually setting the xN speed**

2. When the measurement function is set to [xN], press the SHIFT+FUNC (SPEED) key. The [xN] indicator blinks and the xN speed value is shown on the display.
3. Use the rotary knob and arrow keys (< or >) to set the xN speed value.  
For the procedure to set numeric values, see section 3.7.

- **Selecting the polarity of the data signal**

4. Press the DATA key to select  $\uparrow$  or  $\downarrow$ . The indicator of the selected item lights.

### Setting the measurement function to D-to-C jitter

1. Press the FUNC key to select [DtoC DVD]. The [DtoC DVD] indicator lights.

- **Selecting the slope of the data signal**

2. Press the DATA key to select  $\uparrow$ ,  $\downarrow$ , or both  $\uparrow$  and  $\downarrow$ . The indicator of the selected item lights.

- **Selecting the slope of the clock signal**

3. Press the CLOCK key to select  $\uparrow$  or  $\downarrow$ . The indicator of the selected item lights.



## 4.1 Setting the Measurement Function

### Explanation



There are two measurement functions: 3T jitter and D-to-C jitter. You must specify the conditions of the signal to be measured for each measurement function.

#### Selecting 3T jitter

The measurement range of 3T jitter is  $2.5T$  to  $3.5T$  ( $T = 231.385 \text{ ns}/N$ , where  $N$  is the  $\times N$  speed value). The following table shows the measurement range when  $N$  is 1, 2, 4, 8, and 10:





N	Measurement Range (Unit: ns)
1	578.462 to 809.847
2	289.231 to 404.923
4	144.615 to 202.461
8	72.307 to 101.230
10	57.846 to 80.984

\* Truncate values below the one-thousandths place.

- **$\times 1$ ,  $\times N$**   
Select one of these values when measuring the pulse width of the 3T data signal of a CD to determine the 3T jitter.  $[\times 1]$ , and  $[\times N]$  are used to measure the pulse width of single-speed, and  $\times N$  speed drives, respectively. For details on "N," see "Manual setting of  $\times N$  speed" below.
- **Manual setting of  $\times N$  speed**  
Specify the  $\times N$  speed value  $N$  when measuring the pulse width for speeds other than  $[\times 1]$ . When the value can be specified, the [SET] indicator lights and the  $\times N$  speed value  $N$  is shown on the display.
  - Range: 1.0 to 10.0
  - Resolution: 0.1
- **Selecting the polarity of the data signal**
  - : Measures the positive side (from the rising slope to the next falling slope) of the pulse width.
  - : Measures the negative side (from the falling slope to the next rising slope) of the pulse width.



#### Selecting D-to-C jitter

The measurement range of D-to-C jitter is  $-5 \text{ ns}$  to  $T + 5 \text{ ns}$  (where  $T$  is the period of the measured clock signal).

- **DtoC DVD**  
Select this measurement function when measuring the time difference between the data signal and the clock signal of a DVD to determine the D-to-C jitter.
- **Selecting the slope of the data signal**
  - : The rising slope becomes the measurement starting point of the time difference.
  - : The falling slope becomes the measurement starting point of the time difference.
  - Both  and : The rising and falling slopes alternately become measurement starting points of the time difference.

- **Selecting the slope of the clock signal**

There are two clock signals: the clock signal that is applied to the clock input connector and the clock signal that is regenerated by the PLL circuit. This setting is valid for the clock signal that is applied to the clock input connector. When using the clock signal that is regenerated by the PLL circuit, this setting is made invalid, and the rising slope is always used. For the procedure when using the regenerated clock signal, see section 4.7.

- : Measures the time difference between the measurement starting point of the time difference and the first rising slope of the clock signal.
- : Measures the time difference between the measurement starting point of the time difference and the first falling slope of the clock signal.

#### Selecting BI-PHASE jitter

For an explanation of BI-PHASE jitter, see the TA120E Digital Jitter Meter Option Function User's Manual (IM704420-51E).

#### Note

- If you select [ $\times N$ ] with the FUNC key and set the  $\times N$  speed setting to 6.2, you can measure the pulse width of a single-speed [ $\times 1$ ] DVD using the 3T jitter measurement function.
- The TA120E retains setup information of the measurement conditions for each measurement function ( $\times 1$ ,  $\times N$ , DtoC). However, the setup items that are common on the TA120E such as the ON/OFF condition of the numeric display (see section 5.2), the ON/OFF condition of key lock (see section 7.6), and GP-IB address (see section 8.4) are the same.
- The frequency range of the input clock signal that can be measured is from 25 MHz to 60 MHz.

## 4.2 Turning ON/OFF the Equalizer

«For a functional description, see section 1.4.»

### Keys

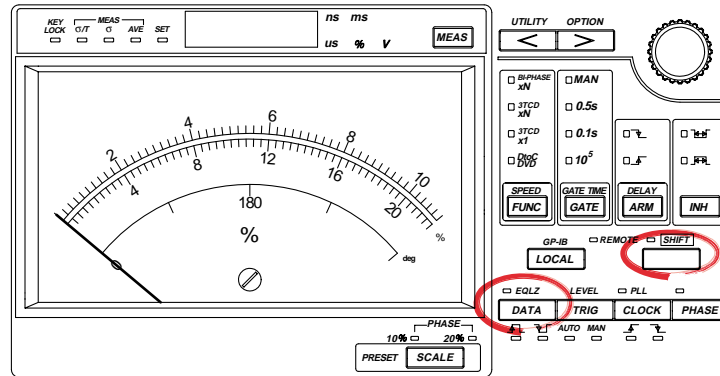

### Procedure

#### Turning ON the equalizer

Press the SHIFT+DATA (EQLZ) key. The EQLZ indicator lights and the equalizer turns ON.

#### Turning OFF the equalizer

Press the SHIFT+DATA (EQLZ) key when the equalizer is ON. The EQLZ indicator turns OFF and the equalizer turns OFF.

### Explanation

When the equalizer is turned ON, you can equalize (compensate) the signal amplitude of the high frequency region.

The signal amplitude in the high frequency region attenuates due to the frequency characteristics of the optical pickup. By passing the RF signal that is applied to the RF input connector through the equalizer, we can obtain a signal that has frequency characteristics that do not attenuate up to the high frequency region (better frequency characteristics than the optical pickup). By equalizing the RF signal, you can make more accurate measurements.

#### Note

The frequency characteristics of the equalizer built into the TA120E comply with the characteristics of the single-speed DVD specification (JIS X 6241 : 1997).

## 4.3 Setting the Trigger Mode and Slice Level

«For a functional description, see section 1.4.»

### Keys

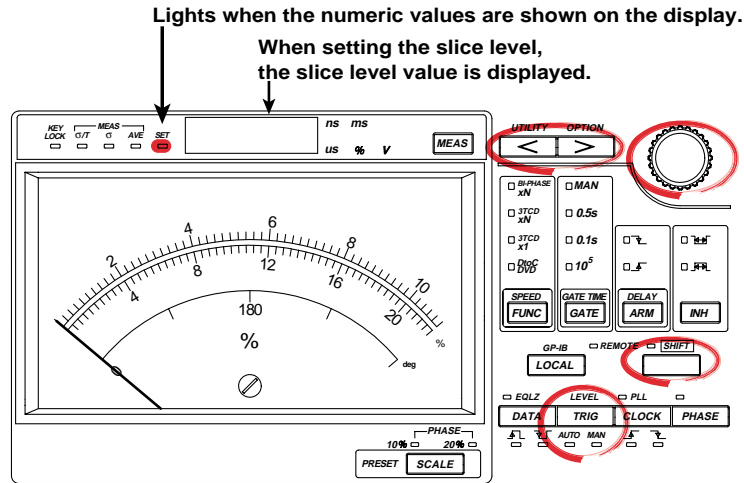

### Procedure

#### Selecting the trigger mode

1. Press the TRIG key to select [AUTO], [MAN], or both [AUTO] and [MAN]. The indicator of the selected item lights.  
If you selected [MAN] or both [AUTO] and [MAN], proceed to step 2.

#### Setting the slice level

2. When the trigger mode is set to [MAN] or both [AUTO] and [MAN], press the SHIFT+TRIG (LEVEL) key. The indicator of the selected trigger mode blinks and the slice level is shown on the display.
3. Use the rotary knob and arrow keys (< or >) to set the slice level.  
For the procedure to set numeric values, see section 3.7.

### 4.3 Setting the Trigger Mode and Slice Level

---

#### Explanation

When measuring the pulse width or time difference of a single pulse, you can select the level of the data signal at which to make the measurement (activate the trigger). Slice level refers to the signal level used to binarize the RF signal. The trigger is activated when the signal passes through the center value of the amplitude of the data signal that has been binarized using the slice level.

#### Setting the trigger mode and slice level

- **AUTO (auto mode)**

The RF signal is binarized using the slice level that is detected by the auto slice circuit. For information about the auto slice function, see section 1.4.

- **MAN (manual mode)**

You can set the slice level in the range shown below. The RF signal is binarized using the specified slice level. When the value can be specified, the [SET] indicator lights and the slice level is shown on the display.

- Range:  $-5.000\text{ V}$  to  $5.000\text{ V}$  ( $-1.000\text{ V}$  to  $1.000\text{ V}$  when the equalizer is ON)
- Resolution:  $1\text{ mV}$

- **[AUTO] and [MAN] (auto + manual mode)**

The RF signal is binarized using the slice level obtained by superimposing a given offset level to the slice level that is detected by the auto slice function. The offset level that is superimposed is set separately from the slice level of the manual mode described above.

- Range:  $-1.000\text{ V}$  to  $1.000\text{ V}$
- Resolution:  $0.001$  (equivalent to approx.  $1\text{ mV}$ )

#### Note

---

If the equalizer is OFF and the slice level of the manual mode exceeds  $1\text{ V}$  (or falls below  $-1\text{ V}$ ) and you turn ON the equalizer, the slice level is set to  $1\text{ V}$  (or  $-1\text{ V}$ ).

---

## 4.4 Setting the Gate

«For a functional description, see section 1.4.»

### Keys

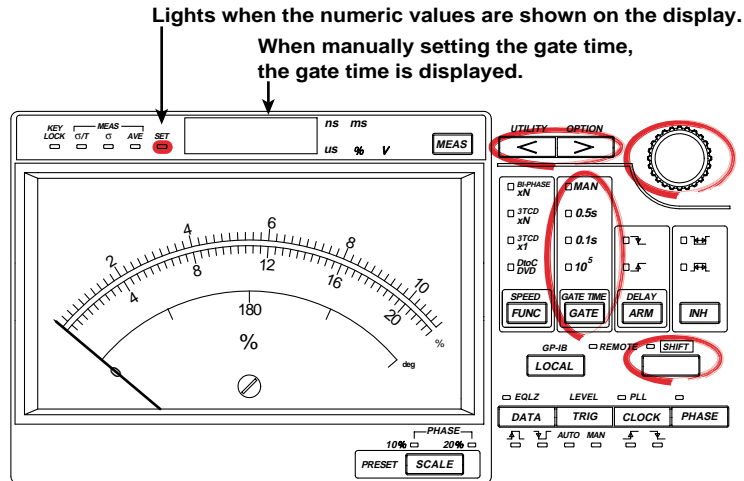

### Procedure

#### Selecting the gate

1. Press the GATE key to select [10<sup>5</sup>], [0.1s], [0.5s], or [MAN]. The indicator of the selected item lights. Event gate is activated when [10<sup>5</sup>] is selected; time gate is activated when [0.1s], [0.5s], or [MAN] is selected. If you selected [MAN], proceed to step 2.

#### Manually setting the gate time

2. When the gate is set to [MAN], press the SHIFT+GATE (GATE TIME) key. The [MAN] indicator blinks and the gate time is shown on the display.
3. Use the rotary knob and arrow keys (< or >) to set the gate time.  
For the procedure to set numeric values, see section 3.7.

## 4.4 Setting the Gate

### Explanation

You can set the number of measured values (number of events) of the pulse width or time difference to be stored in the acquisition memory or the period (gate time) over which the measured values are stored in the acquisition memory.

#### Selecting the gate

- **10<sup>5</sup> (event gate)**  
10<sup>5</sup> measured values are stored in the acquisition memory. Of those values, the measured values that are in the measurement range determined by the measurement function are used to derive the measurement result (jitter). You cannot change the number of events.
- **0.1 s, 0.5 s, and MAN (time gate)**  
[0.1s] and [0.5s] correspond to gate times of 0.1 s and 0.5 s, respectively. [MAN] allows measurement over the manually specified gate time. For details on "MAN," see "Manual setting of the gate time" below.

#### Manual setting of the gate time

When making measurements using a gate time other than [0.1s] or [0.5s], set the gate time in the range shown below. When the value can be specified, the [SET] indicator lights and the gate time is shown on the display.

- Range: 1.0 ms to 1000.0 ms
- Resolution: 0.1 ms

#### Note

If you set the gate time between 100.1 ms and 1000.0 ms, the measured values are acquired in units of 100 ms. The measured values are acquired so that the sum of the gate times in units of 100 ms add up to the specified gate time and determines the jitter (statistical value). The calculated value is displayed or output as a DC level signal (see section 7.1). The portion that is less than 100 ms is processed as shown in the following figure. Meter indication, numeric display, and DC output are updated as shown below.

#### Example in which the gate time is set to 250 ms

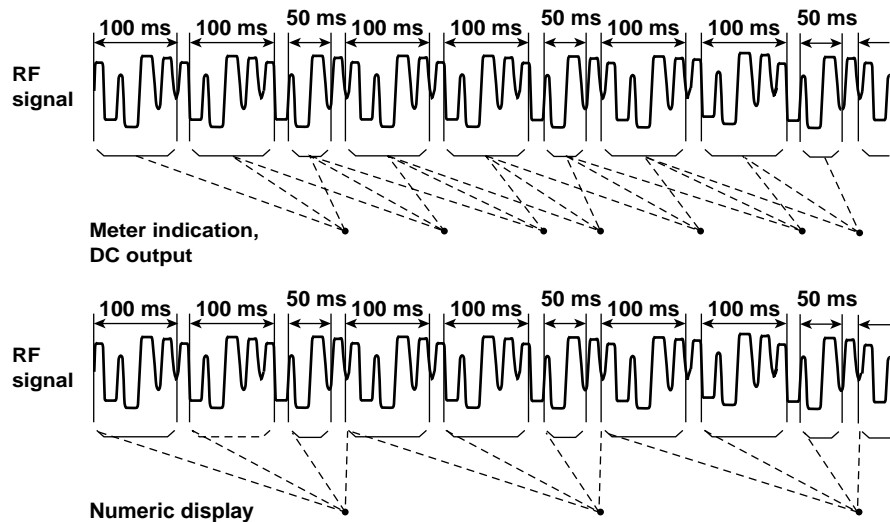

## 4.5 Setting the Arming

«For a functional description, see section 1.4.»

### Keys

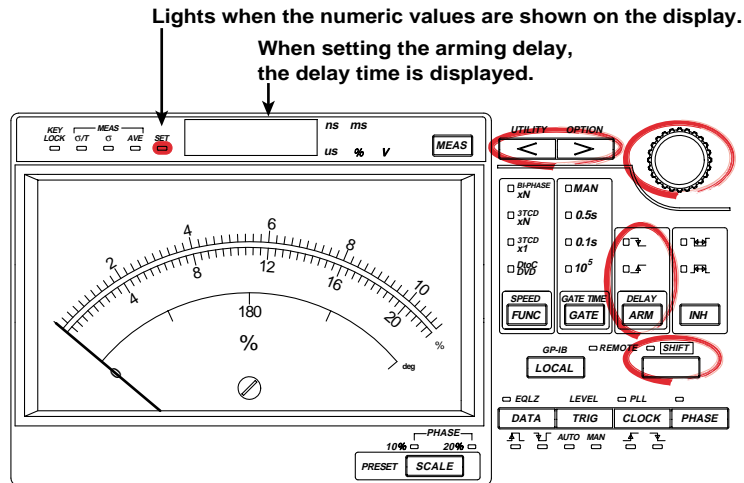

### Procedure

#### Selecting auto arming (internal arming)

Press the ARM key to turn OFF both the  $\overline{\text{A}}$  and  $\overline{\text{B}}$  indicators.

#### Setting the external arming

- **Selecting the slope**

1. Press the ARM key to select  $\overline{\text{A}}$  or  $\overline{\text{B}}$ . The indicator of the selected item lights.

- **Setting the arming delay**

2. When arming is set to external arming (when the slope is set to  $\overline{\text{A}}$  or  $\overline{\text{B}}$ ), press the SHIFT+ARM (DELAY) key. The indicator of the selected slope blinks and the arming delay time is shown on the display.
3. Use the rotary knob and arrow keys (< or >) to set the delay time.  
For the procedure to set numeric values, see section 3.7.



### Explanation

Arming refers to the cue used to start the measurement. As opposed to a trigger, which refers to the cue used to measure the pulse width or time difference of each pulse, arming refers to the starting point of the measurement of a set of pulse widths or time differences used to derive the jitter.

#### Selecting auto arming (internal arming)

If you turn OFF both the  $\uparrow$  and  $\downarrow$  indicators, auto arming is activated. The internal signal of the TA120E is the arming source. Arming is the cue used to start the first measurement (the first trigger).

#### Setting external arming

Arming is activated when an external signal (arming source) is applied to the external arming input connector.

- **Selecting the slope**

- $\uparrow$ : Arming is activated on the rising slope of the external arming signal.
- $\downarrow$ : Arming is activated on the falling slope of the external arming signal.

- **Setting the arming delay**

When using external arming, set the delay time of arming in the range shown below. When the value can be specified, the [SET] indicator lights and the delay time is shown on the display.

- Range: 0.0 ms to 1000.0 ms
- Resolution: 0.1 ms

- **External arming signal**

Input the external arming signal to the connector indicated as "EXT ARM IN" on the rear panel.

Item	Specifications
Input impedance	10 k $\Omega$ (typical value*)
Input coupling	DC
Input level	TTL level
Allowable input voltage range	-8 V to 13 V (DC+ACpeak)
Minimum input pulse width	30 ns
Setup time	0 ns (possible even when the external arming and data signal are simultaneous)

\* The typical value is a representative or standard value. It is not a warranted value.

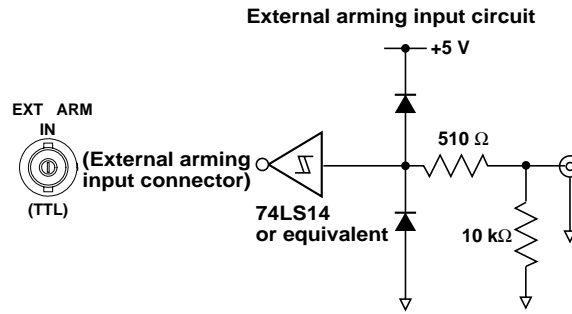

---

**CAUTION**

---

Do not apply a voltage that exceeds the allowable input voltage range to the external arming input connector. This may cause damage to the TA120E.

---

## 4.6 Setting Inhibit

«For a functional description, see section 1.4.»

### Keys

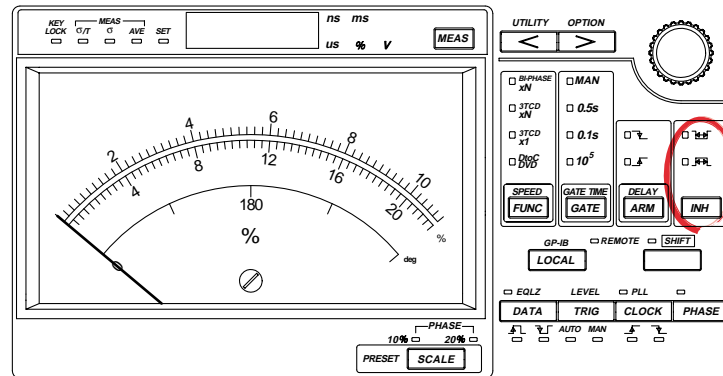

### Procedure

#### Turning ON inhibit and selecting the polarity

Press the INH key to select  $\overline{1}$  or  $\overline{0}$ . The indicator of the selected item lights and inhibit is turned ON.

#### Turning OFF inhibit

Press the INH key to turn OFF both the  $\overline{1}$  and  $\overline{0}$  indicators. Inhibit is turned OFF.

### Explanation

You can inhibit measurements by applying an external signal (inhibit signal) to the INHIBIT input connector. This is possible even while the gate is open or during measurement after arming activation.

#### Selecting the polarity

- $\overline{1}$ : Inhibits measurements while a positive signal is being input.
- $\overline{0}$ : Inhibits measurements while a negative signal is being input.

#### Inhibit signal

Input the inhibit signal to the connector indicated as "INHIBIT" on the rear panel.

Item	Specifications
Input impedance	10 k $\Omega$ (typical value*)
Input coupling	DC
Input level	TTL level
Allowable input voltage range	-8 V to 13 V (DC+ACpeak)
Minimum input pulse width	30 ns
Setup time	0 ns (possible even when the inhibit signal and data signal are simultaneous)

\* The typical value is a representative or standard value. It is not a warranted value.

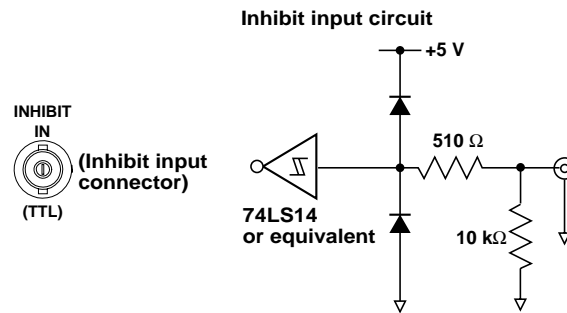
**CAUTION**

Do not apply a voltage that exceeds the allowable input voltage range to the inhibit input connector. This may cause damage to the TA120E.

## 4.7 Switching the Clock Signal (Applicable to D-to-C Jitter Measurements)

«For a functional description, see section 1.4.»

### Keys

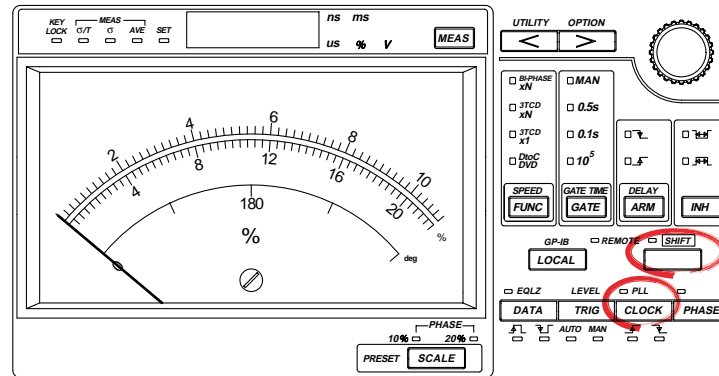

### Procedure

When the measurement function is set to [DtoC DVD] (D-to-C jitter), you can use the regenerated clock signal.

#### Using the regenerated clock signal

Press the SHIFT+CLOCK (PLL) key. The PLL indicator lights and the PLL circuit turns ON. The D-to-C jitter measurements can now be carried out using the regenerated clock signal.

#### Using the clock signal that is applied to the clock input connector

Press the SHIFT+CLOCK (PLL) key while the PLL circuit is ON. The PLL indicator turns OFF, and the PLL circuit turns OFF. The D-to-C jitter measurements can now be carried out using the clock signal that is applied to the clock input connector.

### Explanation

For the clock signal used to measure the D-to-C jitter, you can select either the clock signal that is applied to the clock input connector or the clock signal that is regenerated by the PLL circuit. To use the clock signal regenerated by the PLL circuit, you must turn ON the PLL circuit operation according to the steps above. When the PLL circuit operation is turned ON, the settings made in "Selecting the slope of the clock signal" in section 4.1 are made invalid, and the rising slope is always used.

#### Note

- The clock signal regenerated by the PLL circuit is regenerated from the single-speed data signal of a DVD. Therefore, the frequency range of the regenerated clock signal is  $27\text{ MHz} \pm 10\%$ .
- If the clock cannot be regenerated using the PLL circuit (PLL unlock), the PLL indicator blinks, the meter needle goes off the scales beyond the scale line that indicates the maximum value of each scale, and the characters "unLoC" appear on the display. In addition, the DC output (see section 7.1) is set to 5 V.

## 4.8 Adjusting the Phase Difference between the Data Signal and the Clock Signal (Applicable to D-to-C Jitter Measurements)

«For a functional description, see section 1.4.»

### Keys

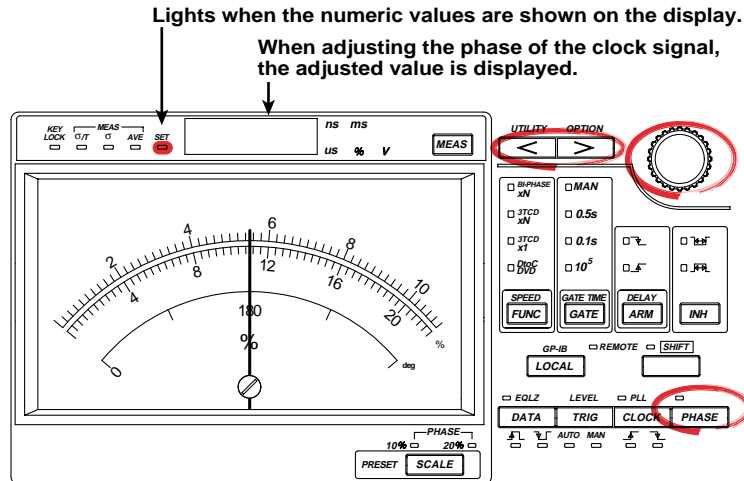

### Procedure

When the measurement function is set to [DtoC DVD] (D-to-C jitter), you can adjust the phase difference of the clock signal.

1. Press the PHASE key. The PHASE indicator blinks, and the 10% and 20% indicators of the SCALE key light. The phase difference (deg) between the data signal and the clock signal is indicated on the analog meter.
2. Use the rotary knob and arrow keys (< or >) to set the phase adjustment value. The meter needle changes according to the changes in the adjustment value.

For the procedure to set numeric values, see section 3.7.

### Explanation

#### Adjusting the phase difference

When using the clock signal that is applied to the clock input connector to make D-to-C jitter measurements, you can change the amount of delay of the clock signal using the internal circuit and adjust the phase difference between the data signal and the clock signal. This cannot be applied to the clock signal that is regenerated by the PLL circuit.

- Range: 0.0 ns to 40.0 ns
- Resolution: 0.1 ns

#### Meter indication of the phase difference

The phase difference between the data signal and the clock signal can be indicated on the analog meter in the range from 0 deg to 360 deg. The scale line is written every 90 degrees. If you adjust the phase difference so that it is 180 (deg), the measured values of the D-to-C is distributed around T/2 (T is the period of the clock signal) resulting in a more accurate D-to-C jitter measurement.

#### Note

When the measurement function is set to [DtoC DVD] (D-to-C jitter) and the PLL circuit is turned OFF, you can adjust the phase difference of the clock signal.

# 5.1 Using the Analog Meter

«For a functional description, see section 1.5.»

**Keys**

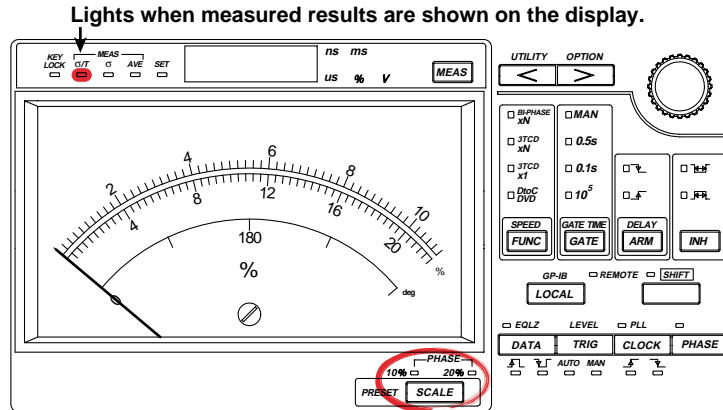

**Procedure**

**Indicating the jitter ratio on the analog meter**

When the TA120E is turned ON, the meter needle indicates the measured jitter ratio.

**Selecting the scale**

Press the SCALE key to select [10%] or [20%]. The needle moves according to the selected scale.

**Explanation**

**Jitter ratio indication on the meter**

The TA120E continuously makes measurements when the power is turned ON. The meter needle indicates the jitter ratio ( $\sigma/T$ ) of the measurement function that was selected in section 4.1.

\* T is the period of the clock signal of the CD or DVD. When the measurement function is 3T jitter,  $T = 231.385/N$  (where N is the xN speed value). When the measurement function is D-to-C jitter, T is the period of the clock signal that is applied to the clock input connector or regenerated by the PLL circuit.

**Selecting the scale**

You can select the scale that is used when indicating the measured jitter ratio on the analog meter.

- 10%  
The scale line is written every 0.2%. The needle is capable of indicating a jitter ratio of up to 11%.
- 20%  
The scale line is written every 0.5%. The needle is capable of indicating a jitter ratio of up to 22%.

**Note**

- The phase difference between the data signal and the clock signal can be indicated on the analog meter in the range from 0 deg to 360 deg. The scale line is written every 90 degrees. For a description on how to use the analog meter when it is indicating the phase difference, see section 4.8.
- The minimum interval for measuring jitter on the TA120E is 50 ms. In some cases, the analog meter may not be able to keep up with the changes in the measured value.
- If the jitter ratio exceeds the maximum value of each scale, the meter needle goes off the scale beyond the scale line that indicates the maximum value of each scale.
- If the trigger is not activated on the input signal and measurements cannot be made, the meter needle goes off the scale beyond the scale line that indicates the maximum value of each scale.
- If the PLL circuit is turned ON during D-to-C measurement and the clock cannot be regenerated using the PLL circuit (PLL unlock), the PLL indicator blinks and the meter needle goes off the scale beyond the scale line that indicates the maximum value of each scale. In addition, the DC output (see section 7.1) is set to 5 V.

## 5.2 Displaying the Numeric Value and Turning OFF the Numeric Display

«For a functional description, see section 1.5.»

### Keys

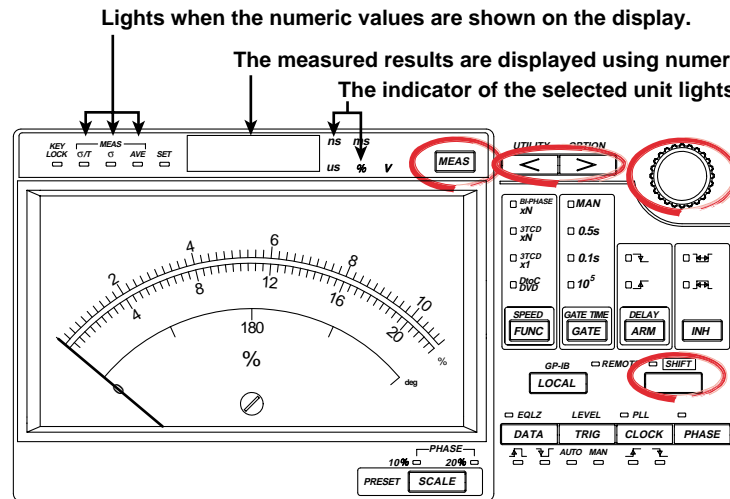

### Procedure

#### Displaying the jitter or jitter ratio using numeric values

Press the MEAS key to select the measured parameter,  $[\sigma/T]$  or  $[\sigma]$ . The indicators for the selected parameter and its unit light.

When  $[\sigma]$  and  $[ns]$  light, the jitter is displayed using numeric values.

When  $[\sigma/T]$  and  $[%]$  light, the jitter ratio is displayed using numeric values.

#### Displaying the average of the measured values

Press the MEAS key to select  $[AVE]$  for the measured parameter. The  $[AVE]$  indicator lights. The average of the measured values is displayed using numeric values.

#### Turning OFF the numeric display

1. Press the SHIFT+<(UTILITY) key. The display shows the characters  $[init]$ .
2. Turn the rotary knob until the characters  $[diSP]$  are displayed.
3. Press the > key. The display shows the characters  $[on]$ .
4. Turn the rotary knob to select  $[oFF]$ .
5. Press the MEAS key to turn OFF the numeric display of measured values. The characters  $[d-OFF]$  are shown on the display.

#### Turning ON the numeric display

1. Press the SHIFT+<(UTILITY) key. The display shows the characters  $[init]$ .
2. Turn the rotary knob until the characters  $[diSP]$  are displayed.
3. Press the > key. The display shows the characters  $[oFF]$ .
4. Turn the rotary knob to select  $[on]$ .
5. Press the MEAS key to display the measured values using numeric values.



**Explanation****Numeric display of jitter, jitter ratio and average value**

The TA120E continuously makes measurements when the power is turned ON. The jitter ratio ( $\sigma/T^{*1}$ ), jitter ( $\sigma$ ), and average value<sup>\*2</sup> of the measurement function that was selected in section 4.1 is displayed using numeric values.

\*1 T is the period of the clock signal of the CD or DVD. When the measurement function is 3T jitter,  $T = 231.385/N$  (where N is the xN value). When the measurement function is D-to-C jitter, T is the period of the clock signal that is applied to the clock input connector or regenerated by the PLL circuit.

\*2 The average value is the average of the time measurement.

When the measurement function is set to 3T jitter: Average of the pulse width of the measured 3T signal

When the measurement function is D-to-C jitter: Time difference average between the data signal and clock signal

- When [ $\sigma$ ] and [ns] light, the jitter is displayed using numeric values.
- When [ $\sigma/T$ ] and [%] light, the jitter ratio is displayed using numeric values.
- When [AVE] and [ns] light, the average of the measured values is displayed using numeric values.

**Turning ON/OFF the numeric display**

If the changes in the numeric display of the jitter or jitter ratio bother you, you can display the characters "d-oFF" instead of displaying the values.

**Note**

- Even when the numeric display is turned OFF, the display shows the setup values when setting the TA120E. For the setup procedure, see chapter 4. Error codes and version information are also shown on the display even when the numeric display is turned OFF.
- If the value to be displayed using numeric values cannot be obtained, the display shows "- - -" (bar).
- If the PLL circuit is turned ON during D-to-C measurement and the clock cannot be regenerated using the PLL circuit (PLL unlock), the PLL indicator blinks, and the characters "unLoC" are shown on the display. In addition, the DC output (see section 7.1) is set to 5 V.
- If numeric display is shown when the average coefficient (see section 7.1) or the jitter ratio correction coefficient (see section 7.1) of the DC output filter is some value other than the initial value, the [ $\sigma/T$ ] (when displaying the jitter ratio) or [ $\sigma$ ] (when displaying the jitter) measurement indicator blinks.
- If the average value is shown when the average coefficient (see section 7.1) of the DC output filter is some value other than the initial value, the [AVE] measurement indicator blinks.

# 6.1 Storing the Setup Information

## Keys

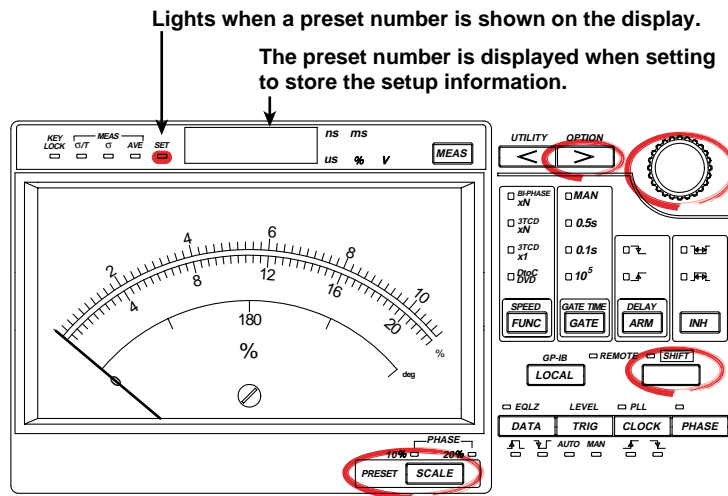

## Procedure

### Selecting the preset number

1. Press the SHIFT+SCALE(PRESET) key. The display shows the characters [PrStx]. The preset number you selected previously is shown in [x]
2. Turn the rotary knob to select the preset number for storing the setup information.

### Storing the setup information

3. Press the > key. The characters [StorE] are displayed for approximately a second, and the setup information is stored. When the setup information is stored, measurement is resumed.

## Explanation

### Setup information that is stored

The following setup information is stored to the memory.  
 All settings such as the measurement function, gate, arming, inhibit, input, and displayed unit excluding the GP-IB address.

### Number of sets for storing presets

The number of sets that can be stored (preset number) is seven from 0 to 6.

### Note

If you initialize all setup information of the TA120E to factory default settings (see section 7.4), the stored setup information is also initialized. The setup information of all seven sets is reset to factory default settings.

## 6.2 Recalling the Setup Information

### Keys

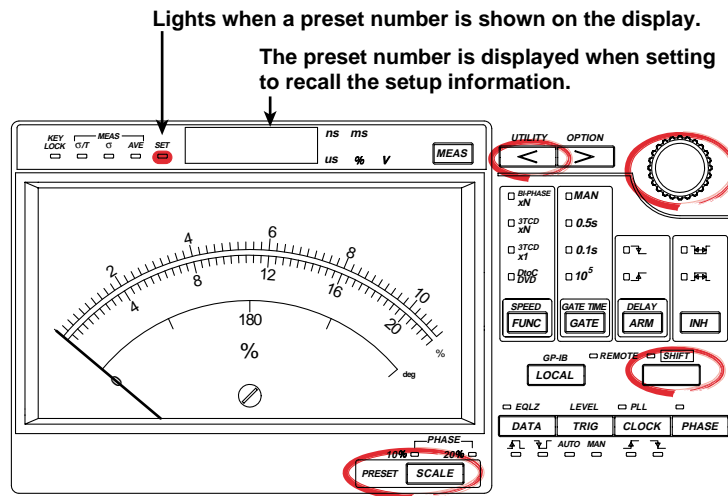

### Procedure

#### Selecting the preset number

1. Press the SHIFT+SCALE(PRESET) key. The display shows the characters [PrStx]. The preset number you selected previously is shown in [x]
2. Turn the rotary knob to select the preset number for recalling the setup information.

#### Recalling the setup information

3. Press the < key. The characters [rECAL] are displayed for approximately a second, and the setup information is recalled. Then, the measurement is started using the recalled setup information.

### Explanation

#### Setup information that is recalled

The setup information that is stored at the specified preset number is recalled, and the current settings are replaced with this information. If no setup information is stored at the specified preset number, the factory default settings are recalled.

#### Number of sets for recalling presets

The number of sets that can be recalled (preset number) is seven from 0 to 6.

## 7.1 Setting the DC Output

«For a functional description, see section 1.6.»

### Connecting the Cable

Connect a BNC cable to the jitter DC output connector on the rear panel of the TA120E.

#### Keys

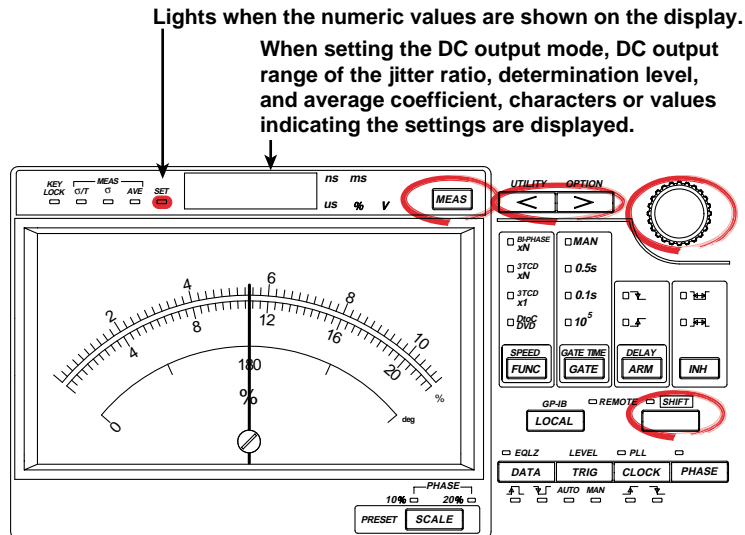

#### Procedure

##### Selecting the DC output mode

1. Press the SHIFT+<(UTILITY) key. The display shows the characters [init].
2. Turn the rotary knob to select [dcout].
3. Press the > key. Turn the rotary knob to select [Jitt] or [JudGE]. If you select [Jitt] (jitter ratio output), a DC voltage corresponding to the jitter ratio is output from the jitter DC output connector. If you select [JudGE] (determination output), a DC voltage of 5 V is output when the jitter ratio is below the determination level and 0 V when the jitter is above the determination level from the jitter DC output connector.

##### Setting the jitter ratio output range

###### • Setting the upper limit of the jitter ratio output range

4. Press the SHIFT+<(UTILITY) key. The display shows the characters [init].
5. Turn the rotary knob to select [dc hi].
6. Press the > key. The display shows the upper limit of the jitter ratio output range.
7. Use the rotary knob and arrow keys (< or >) to set the upper limit. For the procedure to set numeric values, see section 3.7.

###### • Setting the lower limit of the jitter ratio output range

8. Press the SHIFT+<(UTILITY) key. The display shows the characters [init].
9. Turn the rotary knob to select [dc Lo].
10. Press the > key. The display shows the lower limit of the jitter ratio output range.
11. Use the rotary knob and arrow keys (< or >) to set the lower limit. For the procedure to set numeric values, see section 3.7.

### Setting the determination level

12. Press the SHIFT+<(UTILITY) key. The display shows the characters [init].
13. Turn the rotary knob to select [dcJdG].
14. Press the > key. The display shows the determination level.
15. Use the rotary knob and arrow keys (< or >) to set the determination level.  
For the procedure to set numeric values, see section 3.7.

### Setting the average coefficient of the DC output filter

16. Press the SHIFT+<(UTILITY) key. The display shows the characters [init].
17. Turn the rotary knob to select [AVE].
18. Press the > key. The display shows the average coefficient of the DC output filter.
19. Use the rotary knob and arrow keys (< or >) to set the average coefficient.  
For the procedure to set numeric values, see section 3.7.

### Setting the jitter ratio correction coefficient $\alpha$

20. Press the SHIFT+<(UTILITY) key. The display shows the characters [init].
21. Turn the rotary knob to select [ALPHA].
22. Press the > key. The display shows the correction coefficient  $\alpha$ .
23. Use the rotary knob and arrow keys (< or >) to set the jitter ratio correction coefficient  $\alpha$ .  
For the procedure to set numeric values, see section 3.7.

### Setting the jitter ratio correction coefficient $\beta$

24. Press the SHIFT+<(UTILITY) key. The display shows the characters [init].
25. Turn the rotary knob to select [bEtA].
26. Press the > key. The display shows the correction coefficient  $\beta$ .
27. Use the rotary knob and arrow keys (< or >) to set the jitter ratio correction coefficient  $\beta$ .  
For the procedure to set numeric values, see section 3.7.

If you press the MEAS key in the middle or at the end of the setting operation, the information that is specified up to that point is applied to the DC output setting and the measurement operation resumes.

## Explanation

## Setup menu for DC output

The following parameters are specified for the DC output. Use the SHIFT+<(UTILITY) key and the rotary knob to select the parameter you wish to set.

dcout: Selects the DC output mode

dc hi: Sets the upper limit of the jitter ratio output range

dc Lo: Sets the lower limit of the jitter ratio output range

dcJdG: Sets the determination level

AVE: Sets the average coefficient of the DC output filter

ALPHA: Sets the jitter ratio correction coefficient  $\alpha$

bEtA: Sets the jitter ratio correction coefficient  $\beta$

## Selecting the DC output mode

Selects whether to output the jitter ratio or the determination output from the jitter DC output connector on the rear panel.

- **Jitt (jitter ratio output)**

The jitter ratio of the selected measurement function can be converted to DC voltage (0 to 5 V) and output from the jitter DC output connector on the rear panel. You can specify the jitter ratio that will output 5 V (upper limit) and the jitter ratio that will output 0 V (lower limit), and output DC voltage that is proportional to the jitter ratio. 5 V is output for calculated results that exceed 5 V. For setting the upper and lower limits, see “Setting the jitter ratio output range” described later.

When the upper limit is set to 25% and the lower limit to 5%

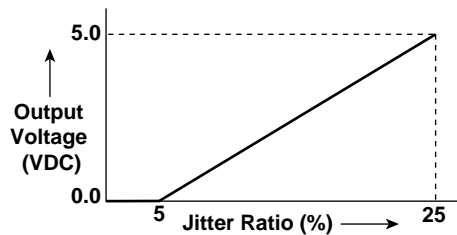

For the update rate of the jitter ratio output, see the note in section 4.4, “Setting the Gate.”

- **JudGE (determination output)**

You can judge the measured jitter ratio against a specified value (determination level). If the jitter ratio is less than or equal to the determination level, a DC voltage of 5 V is output from the jitter DC output connector. When the jitter ratio exceeds the determination level, 0 V is output. For setting the determination level, see “Setting the determination level” described later.

When the determination level is set to 5%

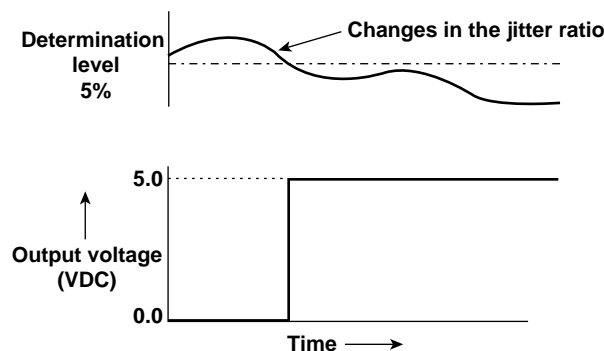

## 7.1 Setting the DC Output

- **DC output circuit**

Item	Specification
Output impedance	50 $\Omega$ (typical value*)
Output level	0 V to 5 VDC, given that the monitor equipment receives the signal at high impedance (approx. 1 M $\Omega$ ).

\* The typical value is a representative or standard value. It is not strictly guaranteed.

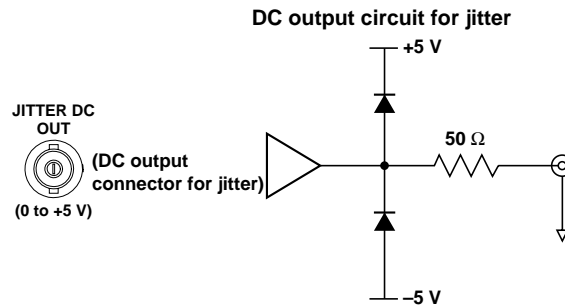

### **CAUTION**

Do not apply external voltage to the output connector. This may cause damage to the TA120E.

#### **Setting the jitter ratio output range**

You can set the upper and lower limits of the jitter ratio output range. The upper and lower limits correspond to 5 VDC and 0 VDC, respectively.

- Range: 0.00% to 100.00%
- Resolution: 0.01%

#### **Setting the determination level**

You can set the determination level for the determination output.

- Range: 0.00% to 100.00%
- Resolution: 0.01%

#### **Setting the average coefficient of the DC output filter**

Takes the moving average of the jitter that has been measured. When the DC output fluctuates due to instability in the measured jitter, this function suppresses the degree of fluctuation. You can set the average coefficient (number of measured values to be averaged) when performing moving average. The jitter ratio that is moving-averaged using the DC output filter is applied to both the jitter ratio output and the determination output. The measured value that is moving averaged is used for the numeric display, meter indication, and DC output.

Range: 1 to 10

**Setting the jitter ratio correction coefficient**

This function corrects the measured jitter ratio using a linear equation. The jitter is the value obtained by multiplying the corrected jitter ratio and the clock value (T). The corrected jitter ratio is used for the numeric display, meter indication, and DC output.

Correction equation:  $\text{Corrected jitter ratio (\%)} = \text{correction coefficient } \alpha \times \text{measured jitter ratio (\%)} + \text{correction coefficient } \beta \text{ (\%)}$

Jitter correction equation:  $\text{Corrected jitter (ns)} = \text{correction coefficient } \alpha \times \text{measured jitter (ns)} + \text{correction coefficient } \beta \text{ (\%)} \times T^*$

\* T is the period of the clock signal of the CD or DVD. When the measurement function is 3T jitter,  $T = 231.385/N$  (where N is the  $\times N$  value). When the measurement function is D-to-C jitter, T is the period of the clock signal that is applied to the clock input connector or regenerated by the PLL circuit.

- Selectable Range

Correction coefficient  $\alpha$ : 0.0001 to 9.9999

Correction coefficient  $\beta$ : -9.999 to 9.999%

- Resolution

Correction coefficient  $\alpha$ : 0.0001

Correction coefficient  $\beta$ : 0.001%

**Note**

- The upper limit must be greater than the lower limit when setting the jitter ratio output range.
- If the average value is shown when the average coefficient of the DC output filter is some value other than the initial value (see section 7.4), the [AVE] measurement indicator blinks.
- When the average coefficient or the jitter ratio correction coefficient is some value other than the initial value (see section 7.4), the  $[\sigma/T]$  (when displaying the jitter ratio) or  $[\sigma]$  (when displaying the jitter) measurement indicator blinks.
- The DC output is 5 V when the trigger is not activated for the input signal and measurements cannot be made.
- If the TA120E becomes unlocked (see section 4.7), the DC output is set to 5 V.



## 7.2 Outputting Other Signals



### CAUTION

Do not apply external voltage to the output connector. This may cause damage to the TA120E.

### Connecting the Cable

Connect a BNC cable to the appropriate output connector on the rear panel of the TA120E.

### Monitor output of RF signals or monitor output of equalized RF signals

You can output the RF signal that is applied to the RF input connector directly to the monitor output on the rear panel. If the equalizer is activated, the equalized RF signal is output.

Item	Specifications
Output impedance	50 $\Omega$ (typical value*)
Output level	When the monitor equipment receives the signal at an input impedance of 50 $\Omega$ , the output level is as follows: <ul style="list-style-type: none"><li>• When the equalizer is OFF<ul style="list-style-type: none"><li>• Approximately 1/4 of the RF signal (within <math>\pm 5</math> V) when the trigger mode is set to manual mode.</li><li>• Approximately 4/5 of the RF signal (within <math>\pm 5</math> V) when the trigger mode is set to auto or auto + manual mode.</li></ul></li><li>• When the equalizer is ON Approx. <math>\pm 0.5</math> V</li></ul>

\* The typical value is a representative or standard value. It is not a warranted value.

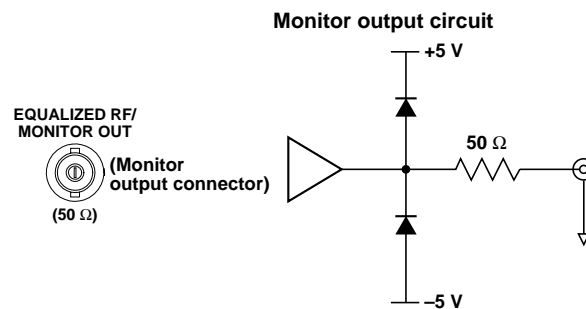

### Outputting the data signal

You can output the data signal obtained through the binarization of the RF signal from the data signal output connector on the rear panel at TTL levels.

Item	Specifications
Output impedance	50 $\Omega$ (typical value*)
Output level	TTL level given that the monitor equipment receives the signal at high impedance (approx. 1 M $\Omega$ ).

\* The typical value is a representative or standard value. It is not a warranted value.

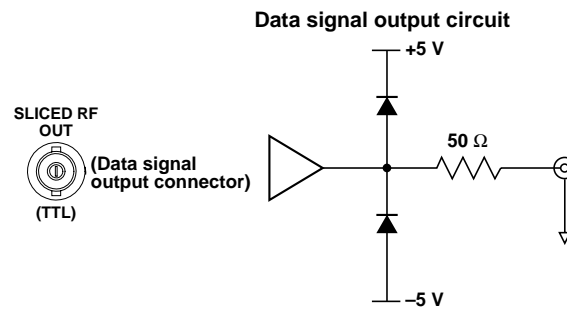

### Outputting the clock signal

You can output the clock signal that is applied to the clock input connector from the clock signal output connector on the rear panel at TTL levels. When the PLL circuit is in operation, the clock signal regenerated by the PLL circuit is output.

Item	Specifications
Output impedance	50 $\Omega$ (typical value*)
Output level	TTL level given that the monitor equipment receives the signal at high impedance (approx. 1 M $\Omega$ ).

\* The typical value is a representative or standard value. It is not a warranted value.

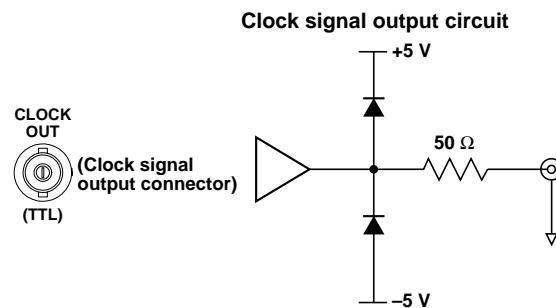

## 7.3 Backing Up the Setup Information

The setup information listed below is stored using the lithium battery. When the power switch is turned ON, the TA120E starts the measurement using the settings that existed immediately before the power switch was turned OFF. If the setup information can no longer be stored due to a dead lithium battery, the TA120E is reset to the factory default settings. For factory default settings, see section 7.4.

Item
Measurement function
Measured item (3T jitter/D-to-C jitter)
Manual setting of the $\times N$ speed (3T jitter)
Polarity of the data signal (3T jitter)
Slope of the data signal (D-to-C jitter)
Slope of the clock signal (D-to-C jitter)
Gate Type
Manual setting of the gate time
Arming type
Slope of the external arming signal
Arming delay setting
ON/OFF condition of inhibit
Polarity
ON/OFF condition of the equalizer
Trigger mode type
Slice level
ON/OFF condition of the PLL circuit
Phase difference adjustment value
Meter scale type
Numeric display type (jitter, jitter ratio, average value)
ON/OFF condition of the numeric display
DC output mode
Upper limit of the jitter ratio output range
Lower limit of the jitter ratio output range
Determination level
Average coefficient of the DC output filter
Jitter ratio correction coefficient $\alpha$
Jitter ratio correction coefficient $\beta$
GP-IB address

### Note

The TA120E retains setup information of the measurement conditions for each measurement function ( $\times 1$ ,  $\times N$ , DtoC). However, the setup items that are common on the TA120E such as the ON/OFF condition of the numeric display (see section 5.2), the ON/OFF condition of key lock (see section 7.6), and GP-IB address (see section 8.4) are the same.

## 7.4 Initializing the Setup Information

There are two methods of initializing the setup information.

### Keys

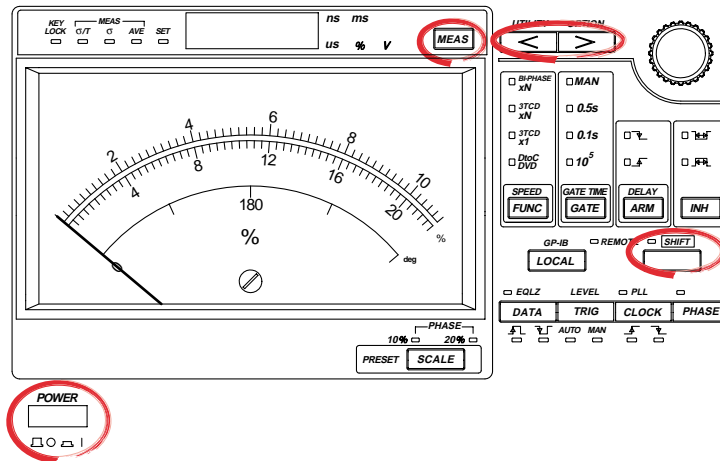

### Procedure

#### Note

- Check that it is okay to initialize the settings before actually initializing the settings. You cannot set the settings back after initialization. We recommend that you transmit the setup information to a PC using a communication command and save the information beforehand.
- If you initialize the settings to factory default, the GP-IB address is also initialized.

#### Initializing the settings to factory default

1. Check that the power switch is turned OFF.
2. While pressing the MEAS key, turn ON the power switch. Hold the MEAS key down for approximately 3 s. The settings are initialized.

#### Initializing the current setup information (settings excluding the GP-IB address and the setup information that is stored in the internal memory)

1. Press the SHIFT+<(UTILITY) key. The display shows the characters [init].
2. Press the > key. The settings are initialized. When the initialization is finished, the characters [donE] are displayed for approximately a second, and the measurement is resumed.

## 7.4 Initializing the Setup Information

### Explanation

The following setup information can be initialized to the factory default settings.

Item	Factory Default Settings
Measurement Function	
Item under measurement	D-to-C jitter
Manual setting of the $\times N$ speed (3T jitter)	1.0
Polarity of the data signal (3T jitter)	Positive
Slope of the data signal (D-to-C jitter)	Rising slope
Slope of the clock signal (D-to-C jitter)	Rising slope
Gate type	105
Manual setting of the gate time	1000.0 ms
Arming type	Auto arming (internal arming)
Slope of the external arming signal	Unselected
Arming delay setting	0.0 ms
ON/OFF condition of inhibit	OFF
Polarity	Unselected
ON/OFF condition of the equalizer	OFF
Trigger mode type	Auto mode
Slice level	0.000 V
ON/OFF condition of the PLL circuit	OFF
Phase difference adjustment value	0.0 ns
Meter scale type	Jitter ratio
Scale	10% scale
Numeric display type (jitter, jitter ratio, or average value)	Jitter ratio
ON/OFF condition of the numeric display	ON
DC output mode	Jitt
Upper limit of the jitter ratio output range	25.00%
Lower limit of the jitter ratio output range	0.00%
Determination level	12.50%
Average coefficient of the DC output filter	1
Jitter ratio correction coefficient $\alpha$	1.0000
Jitter ratio correction coefficient $\beta$	0.000

For the following setup information, the initialized information varies depending on the initialization method.

Item	Initialization to Factory Default Settings	Initialization of the Current Setup Information
Setup information stored to the internal memory	All the setup information (preset numbers 0 through 6) are initialized to factory default settings.	The stored setup information is not initialized.
GP-IB address	1	The GP-IB address is not initialized.

### Note

The communication command “\*RST” initializes the current setup information.

## 7.5 Displaying the Version Information

### Keys

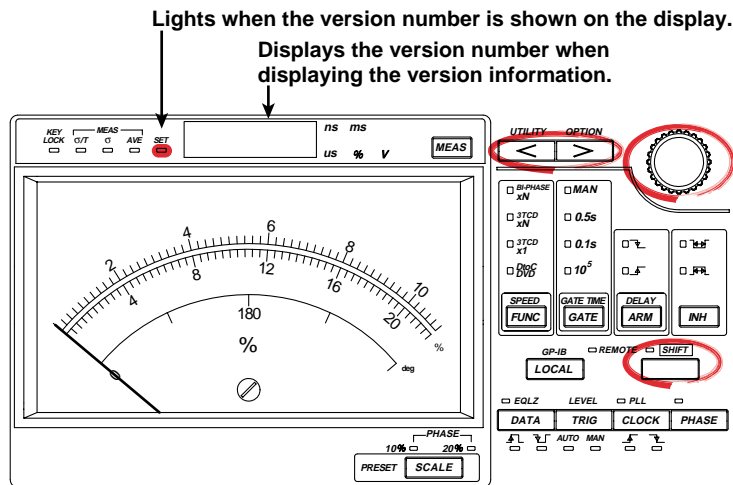

1. Press the SHIFT+<(UTILITY) key. The display shows the characters [init].
2. Turn the rotary knob to select [F-VER].
3. Press the > key. The firmware version (ROM version) is displayed.
4. Press the MEAS key to terminate displaying the version information and resume the measurement.

## 7.6 Key Lock

### Keys

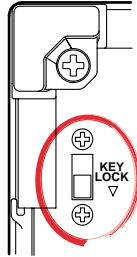

### Procedure

#### Turning ON the key lock

Slide the KEY LOCK switch on the rear panel downward (in the direction of the arrow). The key lock turns ON and the KEY LOCK indicator on the front panel lights. From this point, all key operations except the power switch and the KEY LOCK switch are disabled.

#### Turning OFF (releasing) the key lock

Slide the KEY LOCK switch on the rear panel upward (in the opposite direction of the arrow). The key lock turns OFF and the KEY LOCK indicator on the front panel turns OFF. All key operations are enabled.

### Explanation

You can disable (key lock) the front panel key operation. However, the following switch and key operations are enabled even during key lock:

- Turning ON/OFF the power switch
- Turning ON/OFF the KEY LOCK switch

#### Note

- Key lock can be enabled even when the TA120E is in the remote mode through the communication function.
- Operations in the maintenance mode (see sections 9.4 to 9.6) are available even when key lock is ON.

## 8.1 About the IEEE.488.2-1992 Standard

The GP-IB interface of the instrument conforms to the IEEE 488.2-1992 Standard. This standard specifies that the 23 points listed below be stated in the document. This section will describe these points.

- (1) **The subsets of the IEEE 488.1 interface functions that are supported**  
See "GP-IB Interface Specifications" on page 8-3.
- (2) **The operation of the device when it is assigned an address outside the 0 to 30 range**  
The address of this instrument cannot be set to an address outside the 0 to 30 range.
- (3) **Reaction of the device when the user changes the address**  
The address is changed when a new address is set using the SHIFT+LOCAL key. The new address is valid until the next time it is changed.
- (4) **Device settings at power-up. The commands that can be used at power-up.**  
Basically, the previous settings are used (settings that existed when the power was turned OFF).  
All commands can be used at power-up.
- (5) **Message exchange options**
  - (a) **Input buffer size**  
1024 bytes
  - (b) **Queries that return multiple response messages**  
See the example of the commands given in section 8.7.
  - (c) **Queries that create response data when the command syntax is being analyzed**  
All queries create response data when the command syntax is analyzed.
  - (d) **Queries that create response data during reception**  
There are no queries in which the response data are created upon receiving a send request from the controller.
  - (e) **Commands that have parameters that restrict one another**  
See the example of the commands given in section 8.7.
- (6) **Items that are included in the functional or composite header elements constituting a command**  
See sections 8.6 and 8.7.
- (7) **Buffer sizes that affect block data transmission**  
Data block transmission is not supported.
- (8) **A list of program data elements that can be used in equations and their nesting limitations**  
Equations cannot be used.
- (9) **Syntax of the responses to queries**  
See the example of the commands given in section 8.7.
- (10) **Communication between devices that do not follow the response syntax**  
Not supported.
- (11) **Size of the response data block**  
Not supported.
- (12) **A list of supported common commands**  
See section 8.7.17, "Common Command Group."
- (13) **Device condition after a successful calibration**  
The settings return to the conditions that existed before the calibration, measurements are terminated, and previous measured data are invalidated.
- (14) **The maximum length of block data that can be used for the \*DDT trigger macro definition**  
Not supported.
- (15) **The maximum length of the macro label for defining macros, the maximum length of block data that can be used for the macro definition, and the process when recursion is used in macro definitions**  
Macro functions are not supported.
- (16) **Reply to the \*IDN? query**  
See section 8.7.17, "Common Command Group."



## 8.1 About the IEEE.488.2-1992 Standard

---

- (17) **The size of the storage area for protected user data for \*PUD and \*PUD? commands**  
\*PUD and \*PUD? are not supported.
- (18) **The length of the \*RDT and \*RDT? resource names**  
\*RDT and \*RDT? are not supported.
- (19) **The change in the status due to \*RST, \*LRN?, \*RCL, and \*SAV**  
\*RST  
See section 8.7.17, "Common Command Group."  
\*LRN?, \*RCL, \*SAV  
These common commands are not supported.
- (20) **The extent of the self-test using the \*TST? command**  
The self-test consists of the same tests that are performed at power-up.
- (21) **The structure of the extended return status**  
See section 8.8.
- (22) **Whether each command is processed in an overlap fashion or sequentially**  
See section 8.6.6, "Synchronization with the Controller" and section 8.7.
- (23) **The description of the execution of each command**  
See the functions and procedures in chapters 1 to 9.

## 8.2 GP-IB Interface Functions and Specifications

### GP-IB Interface Functions

#### Listener function

- All of the settings that you can enter with the panel keys can be set through the GP-IB interface except for turning ON/OFF the power and setting the communication parameters.
- Receives commands from a controller requesting the output of setup information, measured data, and other information.
- Also receives status report commands.

#### Talker function

Outputs setup information, measured data, and other information.

#### Note

Talk-only, listen-only, and controller functions are not available on this instrument.

### Switching between Remote and Local Modes

#### When switching from local to remote mode

Receiving a REN (Remote Enable) message from the controller when the instrument is in the local mode causes the instrument to switch to the remote mode.

- The REMOTE indicator turns ON (see page 2-1).
- All keys other than the LOCAL key are locked.
- The settings that existed in the local mode are maintained even when the instrument switches to the remote mode.

#### When switching from remote to local mode

Pressing the LOCAL key when the instrument is in the remote mode causes the instrument to switch to the local mode. However, this act is invalid if the instrument has been set to Local Lockout mode (see next page) by the controller.

- The REMOTE indicator turns OFF.
- Key operations are enabled.
- The settings that existed in the remote mode are maintained even when the instrument switches to the local mode.

### GP-IB Interface Specifications

- **Electrical and mechanical specifications**  
Conforms to IEEE St'd 488-1978
- **Functional specifications**  
See the table below
- **Code**  
ISO (ASCII) code
- **Mode**  
Addressable mode
- **Address setting**  
The address can be set in the range from 0 to 30 using the GP-IB address setting that is displayed with the SHIFT+LOCAL key.
- **Clear remote mode**  
Remote mode can be cleared by pressing the LOCAL key except when the instrument has been set to Local Lockout mode by the controller.

Function	Subset Name	Description
Source handshaking	SH1	Full source handshaking capability
Acceptor handshaking	AH1	Full acceptor handshaking capability
Talker	T6	Basic talker capability, serial polling, untalk on MLA (My Listen Address), and no talk-only capability
Listener	L4	Basic listener capability, unlisten on MTA (My Talk Address), and no listen-only capability.
Service request	SR1	Full service request capability
Remote local	RL1	Full remote/local capability
Parallel polling	PP0	No parallel polling capability
Clear device	DC1	Full device clear capability
Device trigger	DT1	Full device trigger capability
Controller	C0	No controller functions
Electrical characteristics	E1	Open collector

## 8.3 Connecting the GP-IB Cable

### GP-IB Cable

The GP-IB connector used on this instrument is a 24-pin connector that conforms to the IEEE St'd 488.1-1978. Use a GP-IB cable that conforms to this standard.

### Connection Procedure

Connect the cable as shown below.

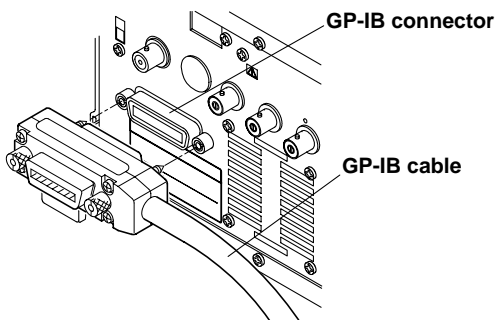

### Precautions to Be Taken When Connecting the Cable

- Firmly tighten the screws on the GP-IB cable connector.
- Multiple devices can be connected to a single GP-IB system. However, no more than 15 devices (including the controller) can be connected to a single system.
- When connecting multiple devices, each device must have its own unique address.
- Use a cable of length 2 m or less for connecting the devices.
- Make sure the total cable length does not exceed 20 m.
- When communicating, have at least two-thirds of the devices turned ON.
- When connecting multiple devices, connect them in a star or linear configuration (see the diagram below). Loop and parallel configurations are not allowed.

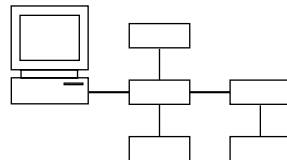
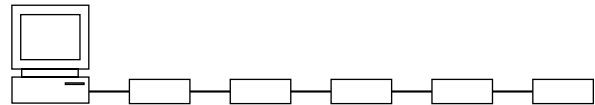

## 8.4 Setting the Address

### Keys

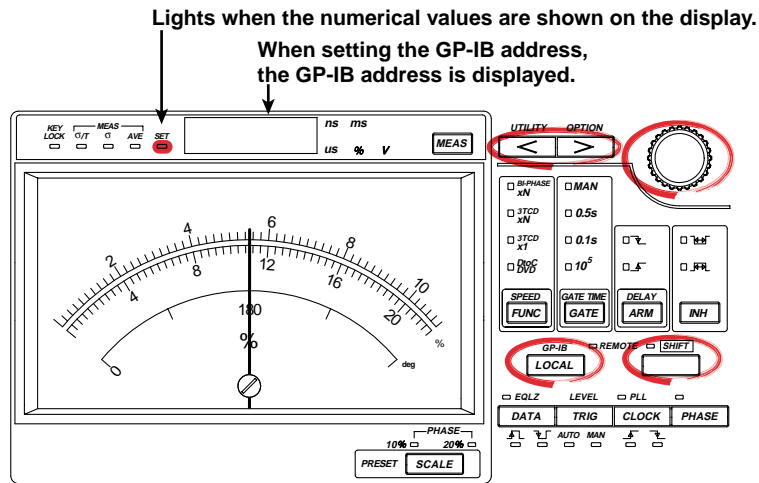

### Procedure

1. Press the SHIFT+LOCAL(GP-IB) key. The GP-IB address is shown on the display.
2. Use the rotary knob and arrow keys (< or >) to set the GP-IB address. For the procedure to set numeric values, see section 3.7.

### Explanation

#### Setting the GP-IB address

Each device that can be connected via GP-IB has a unique address within the GP-IB system. This address is used to distinguish the device from others. When connecting the TA120E, you must select the GP-IB address of the TA120E. Range: 0 to 30

## 8.5 Responses to Interface Messages

### What Is an Interface Message

Interface messages are also referred to as interface commands or bus commands. They are commands that are issued by the controller. They are classified as follows.

#### Uni-line messages

A single control line is used to transmit uni-line messages. The following three messages are available:

IFC (Interface Clear), REN (Remote Enable), and IDY (Identify)

#### Multi-line messages

Eight data lines are used to transmit multi-line messages. The messages are classified as follows:

- Address commands  
These commands are valid when the instrument is designated as a listener or as a talker. The following five commands are available:
  - Commands that are valid on an instrument that is designated as a listener  
GTL (Go To Local), SDC (Selected Device Clear), PPC (Parallel Poll Configure), and GET (Group Execute Trigger)
  - Commands that are valid on an instrument that is designated as a talker  
TCT (Take Control)
- Universal commands  
These commands are valid on all instruments regardless of the listener and talker designations. The following five commands are available: LLO (Local Lockout), DCL (Device Clear), PPU (Parallel Poll Unconfigure), SPE (Serial Poll Enable), and SPD (Serial Poll Disable)
- In addition, listener address, talker address, and secondary commands are also considered interface messages.
- The differences between SDC and DCL  
Of the multi-line messages, SDC messages are those that require talker or listener designation and DCL messages are those that do not require the designation. Therefore, SDC messages are directed at a particular instrument while DCL messages are directed at all instruments on the bus.

### Responses to Interface Messages

#### Responses to a uni-line message

- IFC  
Clears the talker and listener functions. Stops output if data are being output.
- REN  
Switches between the remote and local modes.
- IDY  
Not supported.

#### Responses to a multi-line message (address command)

- GTL  
Switches to the local mode.
- SDC  
Clears the program message (command) being received and the output queue (see page 8-40).
- GET  
Same operation as the “\*TRG” command.
- The COMMunicate:WAIT command is immediately terminated.
- PPC and TCT: Not supported.

#### Responses to a multi-line message (universal command)

- LLO  
Disables the LOCAL key on the front panel to prohibit switching to the local mode.
- DCL  
Same operation as the SDC message.
- SPE  
Sets the talker function on all devices on the bus to serial polling mode. The controller polls the devices in order.
- SPD  
Clears the serial polling mode of the talker function on all devices on the bus.
- PPU  
Not supported.

## 8.6 Program Format

### 8.6.1 Symbols Used in the Syntax

The following table contains symbols that are used for syntax, mainly in section 8.7. These symbols are referred to as BNF (Backus-Naur Form) symbols. For details on the data, see pages 8-11 to 8-13.

Symbol	Meaning	Example
<x>	Defined value	STATus:FILTer<x> <x>=1 to 16 Input example STATUS:FILTER2
{ }	Select from values given in { }	MEASure:FUNCTion {DTCID3T} Input example; MEASURE:FUNCTION DTOC
	Exclusive OR	MEASure:FUNCTion {DTCID3T} Input example; MEASURE:FUNCTION DTOC
[ ]	Can be omitted	INPut:PLL[:MODE]
..	Can be repeated	

### 8.6.2 Messages

#### Messages

Messages are used to exchange information between the controller and the instrument. Messages that are sent from the controller to the instrument are called program messages and messages that are sent back from the instrument to the controller are called response messages.

If a program message contains a message unit that requests a response (a query), the instrument returns a response message upon receiving the program message. A single response message is always returned in response to a single program message.

#### Program Messages

Data that are sent from the controller to the instrument are called program messages. The program message format is shown below.

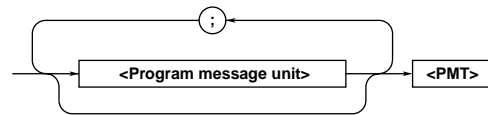

#### <Program Message Unit>

A program message consists of one or more program message units; each unit corresponds to one command. The instrument executes the received commands in order.

Each program message unit is separated by a semicolon (;).

For details regarding the format of the program message unit, see the next section.

Example;  
 :MEASURE:FUNCTION D3T;SPEED 1.0<PMT>  
 Unit Unit

## 8.6 Program Format

### <PMT>

PMT is a program message terminator. The following three types of terminators are available.

- NL (New Line)  
Same as LF (Line Feed). ASCII code "0AH"
- ^END  
The END message (EOI signal) as defined in the IEEE488.1. (The data byte that is sent with the END message will be the last data of the program message.)
- NL^END  
NL with an END message attached. (NL is not included in the program message.)

### Program message unit format

The program message unit format is shown below.

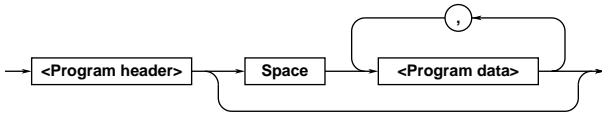

### <Program Header>

The program header indicates the command type. For details, see page 8-9.

### <Program Data>

If certain conditions are required in executing a command, program data are added. A space (ASCII code "20H") separates the program data from the header. If there are multiple sets of program data, they are separated by commas (,).

For details, see page 8-11.

Example: `SAMPLE:GATE:MODE EVENT<PMT>`

## Response Messages

Data that are sent from the instrument to the controller are called response messages. The response message format is shown below.

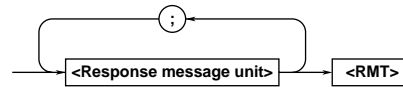

### <Response Message Unit>

A response message consists of one or more response message units; each response message unit corresponds to one response.

Response message units are separated by a semicolon (;).

For details regarding the format of the response message unit, see the next section.

Example;

`:SAMPLE:INHIBIT:STATE 1;POLARITY POSITIVE<RMT>`

### <RMT>

<RMT> is a response message terminator. It is NL^END.

### Response message unit format

The response message unit format is shown below.

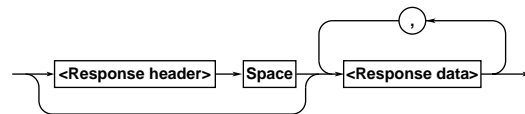

### <Response Header>

A response header sometimes precedes the response data. A space separates the data from the header.

For details, see page 8-11.

### <Response Data>

Response data contain the content of the response. If there are multiple sets of response data, they are separated by commas (,).

Example;

`500.0E-03<RMT> :SAMPLE:GATE:MODE TIME<RMT>`

If there are multiple queries in a program message, responses are made in the same order as the queries. In most cases, a single query returns a single response message unit, but there are a few queries that return multiple units. The first response message unit always corresponds to the first query, but the nth response unit may not necessarily correspond to the nth query. Therefore, if you want to make sure that every response is retrieved, divide the program messages into individual messages.

### Precautions to Be Taken when Transferring Messages

- If a program message that does not contain a query is sent, the next program message can be sent at any time.
- If a program message that contains a query is sent, a response message must be received before the next program message can be sent. If the next program message is sent before the response message is received in its entirety, an error occurs. The response message that was not received is discarded.
- If the controller tries to receive a response message when there is none, an error occurs. If the controller tries to receive a response message before the transmission of the program message is complete, an error occurs.
- If a program message containing multiple message units is sent, and the message contains incomplete units, the instrument will attempt to execute the ones that are believed to be complete. However, these attempts may not always be successful. In addition, if the message contains queries, the responses may not be returned.

### Deadlock

The instrument can store response messages of length 1024 bytes or more in its buffer (The number of available bytes varies depending on the operating conditions). When both the transmit and receive buffers become full at the same time, the instrument can no longer continue to operate. This state is called a deadlock. In this case, operation can be resumed by discarding the program message.

Deadlock will not occur if the program message (including the <PMT>) is kept below 1024 bytes. Furthermore, deadlock never occurs if a program message does not contain a query.

## 8.6.3 Commands

### Commands

There are three types of commands (program headers) that are sent from the controller to the instrument. They differ in their program header formats.

### Common Command Header

Commands that are defined in the IEEE 488.2-1987 are called common commands. The header format of a common command is shown below. An asterisk (\*) is always placed in the beginning of a command.

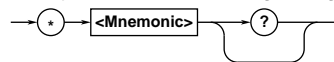

An example of a common command; \*CLS

### Compound Header

Dedicated commands used by the instrument are classified and arranged in a hierarchy according to their functions. The format of a compound header is shown below. A colon (:) must be used to specify a lower hierarchy.

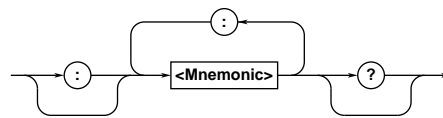

An example of a compound header;  
MEASURE : FUNCTION

### Simple Header

These commands are functionally independent and do not have a hierarchy. The format of a simple header is shown below.

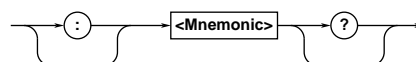

An example of a simple header; START

### Note

<mnemonic> is a character string made up of alphanumeric characters.



### When Concatenating Commands

#### Command group

A command group is a group of commands that have common compound headers arranged in a hierarchy. A command group may contain sub-groups.

Example Group of commands related to sampling

```
SAMPLE?  
SAMPLE: ARMING  
SAMPLE: ARMING: DELAY: TIME  
SAMPLE: ARMING: SLOPE  
SAMPLE: ARMING: SOURCE  
SAMPLE: GATE?  
SAMPLE: GATE: MODE  
SAMPLE: GATE: TIME  
SAMPLE: INHIBIT?  
SAMPLE: INHIBIT: POLARITY  
SAMPLE: INHIBIT: STATE
```

#### When concatenating commands of the same group

The instrument stores the hierarchical level of the command that is currently being executed, and performs analysis on the assumption that the next command sent will also belong to the same level. Therefore, common header sections can be omitted for commands belonging to the same group.

Example;

```
INPUT: DATA: TRIG: MODE MAN; LEVEL 1.000V<PMT>
```

#### When concatenating commands of different groups

If the following command does not belong to the same group, a colon (:) is placed in front of the header.

Example;

```
MEASURE: FUNCTION DTOC; : DISPLAY: SCALE R10<PMT>
```

#### When concatenating simple headers

If a simple header follows another command, a colon (:) is placed in front of the simple header.

Example;

```
MEASURE: FUNCTION DTOC; : START<PMT>
```

#### When concatenating common commands

Common commands that are defined in the IEEE 488.2-1992 are independent of hierarchy. Colons (:) are not needed before a common command.

Example;

```
MEASURE: FUNCTION D3T; *CLS; SPEED 1.0<PMT>
```

### When separating commands with <PMT>

If a terminator is used to separate two commands, each command is a separate message. Therefore, the common header must be specified for each command even when commands belonging to the same command group are being concatenated.

Example;

```
MEASURE: FUNCTION D3T<PMT>MEASURE:  
SPEED 1.0<PMT>
```

### Upper-level Query

An upper-level query is a query in which a question mark (?) is appended to the highest level command of a group. Execution of an upper-level query allows all settings that can be specified in the group to be received at once. Some query groups which are comprised of more than three hierarchical levels can output all the lower level settings.

Example;

```
SAMPLE?<PMT>→: SAMPLE: ARMING: SOURCE AUTO; :  
SAMPLE: GATE: MODE TIME; TIME 100.0E-03; :  
SAMPLE: INHIBIT: STATE 0
```

The response to an upper-level query can be transmitted as a program message back to the instrument. In this way, the settings that existed when the upper-level query was made can be restored. However, some upper-level queries will not return setup information that is not currently in use. It is important to remember that not all the group's information is necessarily returned as part of a response.

### Header Interpretation Rules

The instrument interprets the header that is received according to the following rules:

- Upper-case and lower-case letters of a mnemonic are treated the same.  
Example "MEASure" can also be written as "measure" or "Measure."
- The lower-case section of the header can be omitted.  
Example "MEASure" can also be written as "MEASU" or "MEAS."
- The question mark (?) at the end of a header indicates that it is a query. The question mark (?) cannot be omitted.  
Example The shortest abbreviation for "MEASure?" is "MEAS?".
- If the <x> (value) at the end of a mnemonic is omitted, it is interpreted as a 1.  
Example If "FILTer<x>" is written as "FILT," it means "FILTer1."
- The section enclosed by braces ([]) can be omitted.  
Example "INPut: PLL[:MODE] 1" can be written as "INPut: PLL 1."  
However, the last section enclosed by braces ([]) cannot be omitted in an upper-level query.

## 8.6.4 Responses

When the controller sends a message unit that has a question mark (?) in its program header (query), the instrument returns a response message to the query. A response message is returned in one of the following two forms:

- Response consisting of a header and data  
If the response can be used as a program message without any change, it is returned with a command header attached.  
Example;  
SAMPLE : GATE : MODE ? <PMT> → : SAMPLE : GATE :  
MODE EVENT <RMT>
- Response consisting of data only  
If the response cannot be used as a program message unless changes are made to it (query-only command), only the data section is returned. However, there are query-only commands that return responses with the header attached.  
Example;  
STATUS : ERROR ? <PMT> → 0, "NO ERROR" <RMT>

### When you wish to return a response without a header

Responses that return both header and data can be set so that only the data section is returned. Use the "COMMunicate:HEADer" command for this task.

### Abbreviated form

The response header is normally returned with the lower-case section removed. You can change this so that the response header is in the full form. Use the "COMMunicate:VERBose" command for this task. The sections enclosed by braces ([]) are also omitted in the abbreviated form.

## 8.6.5 Data

### Data

Data contain conditions and values that are written after the header. A space is used to separate the header and data. Data are classified as follows:

Data	Description
<Decimal>	Value expressed as a decimal number (Example; Recall the information to be specified → RECALL 2)
<Voltage><Time> <Phase> <Percent>	Physical value (Example; Gate time → SAMPLE : GATE : TIME 1MS)
<Register>	Register value expressed as either binary, octal, decimal or hexadecimal. (Example; Extended event register value → STATUS : EESE #HFE)
<Character data>	Predefined character string (mnemonic). Selectable from { } (Example; Gate mode selection → SAMPLE : GATE : MODE {EVENT   TIME})
<Boolean>	Indicates ON and OFF. Use "ON," "OFF," or a value. (Example; Turn ON the equalizer display → INPUT : EQ : MODE ON)

### <Decimal>

<Decimal> indicates a value expressed as a decimal number, as shown in the table below. Decimal values are given in the NR form as specified in the ANSI X3.42-1975.

Symbol	Description	Example
<NR1>	Integer	125 -1 +1000
<NR2>	Fixed point number	125.0 -.90 +001.
<NR3>	Floating point number	125.0E+0 -9E-1 +.1E4
<NRf>	Any of the forms <NR1> to <NR3> is allowed.	

- The instrument can receive decimal values that are sent from the controller in any of the forms, <NR1> to <NR3>. This is represented by <NRf>.
- For response messages that the instrument returns to the controller, a specific form <NR1> to <NR3> is defined for each query. The same form is used regardless of the size of the value.
- For the <NR3> format, the "+" sign after the "E" can be omitted. However, the "-" sign cannot be omitted.
- If a value outside the setting range is entered, the value will be changed to the closest value inside the range.
- If a value has more significant digits than the available resolution, the value is rounded.

## 8.6 Program Format

### <Voltage>, <Time>, <Phase>, <Percent>

<Voltage>, <Time>, <Phase>, and <Percent> indicate decimal values that have physical dimensions.

<Multiplier> or <Unit> can be attached to the <NRf> format that was described earlier. Enter these using any of the following forms:

Form	Example
<NRf><Multiplier><Unit>	5MV
<NRf><Unit>	5E-3V
<NRf><Multiplier>	5M
<NRf>	5E-3

### <Multiplier>

<Multipliers> given in the following table can be used:

Symbol	Prefix	Multiplier
EX	Exa	$10^{18}$
PE	Peta	$10^{15}$
T	Tera	$10^{12}$
G	Giga	$10^9$
MA	Mega	$10^6$
K	Kilo	$10^3$
M	Milli	$10^{-3}$
U	Micro	$10^{-6}$
N	Nano	$10^{-9}$
P	Pico	$10^{-12}$
F	Femto	$10^{-15}$
A	Ato	$10^{-18}$

### <Unit>

<Unit> given in the following table can be used:

Symbol	Word	Description
V	Volt	Voltage
S	Second	Time
PCT	Percent	Percentage

- <Multiplier> and <Unit> are not case sensitive.
- "U" is used to indicate the micro "μ."
- "MA" is used for Mega to distinguish it from Milli.
- If both <Multiplier> and <Unit> are omitted, the default unit is used.
- Response messages are always in the <NR3> form. Response messages are returned using the default unit without the <Multiplier> or <Unit>.

### <Register>

<Register> indicates an integer that can be expressed not only in <Decimal> notation, but also <Hexadecimal>, <Octal>, or <Binary>. <Register> is used when each bit of the value has a particular meaning. It is expressed in one of the following forms:

Form	Example
<NRf>	1
#H<Hexadecimal value made up of the digits 0 to 9 and A to F>	#H0F
#Q<Octal value made up of the digits 0 to 7>	#q777
#B<Binary value made up of the digits 0 and 1>	#B001100

- <Register> is not case sensitive.
- Response messages are always returned in the <NR1> form.

### <Character Data>

<Character data> are predefined character strings (mnemonic). They are mainly used to indicate options. One of the character strings given in brackets {} is chosen. The data interpretation is the same as the description given in "Header Interpretation Rules" on page 8-10.

Form	Example
{EVENT TIME EXTERNAL}	EVENT

- As with the header, the "COMMunicate:VERBose" command can be used to select whether to return the response in the full form or in the abbreviated form.
- The "COMMunicate:HEADer" setting does not affect the <character data>.

### <Boolean>

<Boolean> are data that indicate ON or OFF. They are expressed in one of the following forms:

Form	Example
{ON OFF <NRf>}	ON OFF 1 0

- When <Boolean> is expressed in the <NRf> form, OFF is selected if the rounded integer value is "0," and ON for all other cases.
- A response message is always returned with a "1" if the value is ON and "0" if the value is OFF.

### <Character String Data>

Unlike the predefined character strings of <Character data>, <Character string data> is an arbitrary character string. The character string is enclosed in single quotation marks (') or double quotation marks (").

Form	Example
<Character string data>	'ABC' "IEEE488.2-1987"

- If the character string contains a double quotation mark ("), it is represented by ("""). This rule also applies to a single quotation mark (').
- A response message is always enclosed in double quotation marks (").
- Because <Character string data> is an arbitrary character string, if the last single quotation mark (') or double quotation mark (") is missing, the instrument may assume that the remaining program message units are part of the <Character string data> and may not detect the error.

### 8.6.6 Synchronization with the Controller

This instrument does not support overlap commands, which allows the execution of the next command to start before the execution of the previous command is completed. If multiple sequential commands—the type of commands supported by this instrument—are sent consecutively, the execution of the next command is delayed until the execution of the previous command is completed.

#### Synchronization Using Sequential Commands

Even for sequential commands, synchronization is sometimes required for non communication-related reasons such as a trigger occurrence.

For example, if the next program message is sent when querying the measured data of a single measurement, "CALCulation:JITTer?" is executed regardless of whether the data acquisition has finished and may result in a command execution error.

```
:SSTart;:CALCulation:JITTer?<PMT>
```

In this case, the following method must be used to synchronize with the end of the acquisition:

#### Using the STATus:CONDition? query

The "STATus:CONDition?" query is used to query the contents of the condition register (page 8-39). You can determine whether or not the measured data are valid by reading bit 0 of the condition register. If bit 0 of the condition register is "1," the measured data are valid. If it is "0," measurement or computation is in progress and the measured data are invalid.

Example :SSTart<PMT>

```
STATus:CONDition?<PMT>
```

(Read the response. If bit 0 is 0, repeat this command until it becomes 1.)

```
CALCulation:JITTer?<PMT>
```

## 8.6 Program Format

---

### Using the extended event register

The changes in the condition register can be reflected in the extended event register (page 8-39).

```
Example  STATus:FILTer1 RISE;:STATus:
        EESE 1;EESR?;
        *SRE 8;SStart<PMT>
        (Wait for a service request)
        CALCulation:JITTer?<PMT>
```

The “STATus:FILTer1 RISE” command sets the transition filter so that bit 0 (FILTer1) of the extended event register is set to “1” when bit 0 of the condition register changes from “0” to “1.”

The “STATus:EESE 1” command is used to reflect only bit 0 of the extended event register to the status byte.

The “STATus:EESR?” command is used to clear the extended event register.

The “\*SRE” command is used to generate a service request solely on the cause of the extended event register.

The “CALCulation:JITTer?” command will not be executed until a service request is generated.

### Using the COMMunicate:WAIT command

The “COMMunicate:WAIT” command is used to wait for a specific event to occur.

```
Example  STATus:FILTer1 RISE;:STATus:EESR?;
        SStart<PMT>
        (Read the response to STATus:EESR?)
        COMMunicate:WAIT 1;:CALCulation:
        JITTer?<PMT>
```

The descriptions of “STATus:FILTer1 RISE” and “STATus:EESR?” are the same as those given in the previous section regarding the extended event register.

The “COMMunicate:WAIT 1” command indicates that the program will wait for bit 0 of the extended event register to be set to “1.”

The “CALCulation:JITTer?” command will not be executed until bit 0 of the extended event register is set to “1.”

---

### Note

On the TA120E, the statistical data can be read during measurement without having to synchronize with the controller. The value queried in this case is the previous statistical value.

```
Example  CALCulation:JITTer?<PMT>
```

---

## 8.7 Commands

### 8.7.1 A List of Commands

Command	Function	Page
<b>CALCulation Group</b>		
:CALCulation:AVERage?	Queries the average value.	8-18
:CALCulation:ELERror?	Queries the Effect Length Error.	8-18
:CALCulation:FLUTter?	Queries the $\sigma$ /AVE value.	8-18
:CALCulation:JITTer?	Queries the jitter ratio.	8-18
:CALCulation:MAXimum?	Queries the maximum value.	8-18
:CALCulation:MELE?	Queries the MELE value.	8-18
:CALCulation:MINimum?	Queries the minimum value.	8-18
:CALCulation:PHASe?	Queries the phase difference between the data signal and the clock signal.	8-18
:CALCulation:PTOPeak?	Queries the P-P value.	8-18
:CALCulation:SDEVIation?	Queries the standard deviation (jitter $\sigma$ ).	8-18
:CALCulation:SNUMber?	Queries the number of samples of the data signal.	8-19
:CALCulation:TVALue?	Queries the period of the clock signal.	8-19
<b>COMMunicate Group</b>		
:COMMunicate?	Queries all settings related to communications.	8-20
:COMMunicate:HEADer	Sets whether or not to attach a header to the response data or queries the current setting (ON/OFF).	8-20
:COMMunicate:VERBoSe	Sets the response messages to full form or abbreviated form or queries the current setting.	8-20
:COMMunicate:WAIT	Waits for a specified extended event.	8-20
:COMMunicate:WAIT?	Creates the response that is returned when the specified event occurs.	8-20
<b>DCOut Group</b>		
:DCOut?	Queries all settings related to the DC output of the jitter ratio.	8-21
:DCOut:JITTer:COEfficient	Sets the jitter ratio correction coefficient or queries the current setting.	8-21
:DCOut:JITTer:CYCLE	Sets the average coefficient of the DC output of the jitter ratio or queries the current setting.	8-21
:DCOut:JITTer:RANGe	Sets the upper and lower limits of the DC output of the jitter ratio or queries the current setting.	8-21
:DCOut:JUDGE:LEVeL	Sets the determination level or queries the current setting.	8-21
:DCOut:JUDGE:RESuLt?	Queries the determination result.	8-22
:DCOut:MODE	Sets the DC output mode or queries the current setting.	8-22
<b>DISPlay Group</b>		
:DISPlay?	Queries all settings related to the analog meter.	8-22
:DISPlay:MEASure	Sets the measured value to be displayed or queries the current setting.	8-22
:DISPlay:SCALe	Sets the scale of the analog meter or queries the current setting.	8-22
:DISPlay:STATistic	Turns ON/OFF the numeric display or queries the current setting.	8-22
<b>INPut Group</b>		
:INPut?	Queries all settings related to the input signal.	8-24
:INPut:CLOCK?	Queries all settings related to the clock signal input.	8-24
:INPut:CLOCK:DELAy?	Queries all settings related to the phase delay of the clock signal.	8-24
:INPut:CLOCK:DELAy:TIME	Sets the phase delay time of the clock signal or queries the current setting.	8-24
:INPut:CLOCK:SLOPe	Sets the slope of the clock signal or queries the current setting.	8-24
:INPut:DATA:POLarity	Sets the polarity of the data signal or queries the current setting.	8-24
:INPut:DATA:TRIGger?	Queries all settings related to the trigger.	8-24
:INPut:DATA:TRIGger:MODE	Sets the trigger mode or queries the current setting.	8-24
:INPut:DATA:TRIGger:LEVeL	Sets the slice level or queries the current setting.	8-24
:INPut:EQ[:MODE]	Turns ON/OFF the equalizer or queries the current setting.	8-24
:INPut:PLL[:MODE]	Sets the PLL or queries the current setting.	8-25
:INPut:PLL:STATus?	Queries the lock condition (when the clock signal could be regenerated from the data signal) of the PLL.	8-25

## 8.7 Commands

Command	Function	Page
<b>MEASure Group</b>		
:MEASure?	Queries all settings related to the measurement.	8-25
:MEASure:FUNcTion	Sets the measurement function or queries the current setting.	8-25
:MEASure:SPEed	Sets the $\times N$ speed or queries the current setting.	8-25
<b>MEMory Group</b>		
:MEMory?	Queries all settings related the external transmission of the measured data.	8-26
:MEMory:BYTeorder	Sets the transmission order of binary data or queries the current setting.	8-26
:MEMory:DATaselect	Sets the data to be transmitted or queries the current setting.	8-26
:MEMory:END?	Queries the end position of the data to be transmitted.	8-27
:MEMory:Format	Sets the format of the data to be transmitted or queries the current setting.	8-27
:MEMory:SEND?	Executes the transmission of the measured data specified by "MEMory:DATaselect."	8-27
:MEMory:SIZE?	Queries the number of data points that have been measured.	8-27
:MEMory:START?	Queries the start position of the data to be transmitted.	8-27
<b>RECall Group</b>		
:RECall	Recalls the setup information.	8-28
<b>SAMPle Group</b>		
:SAMPle?	Queries all settings related to the acquisition of the input signal.	8-29
:SAMPle:ARMinG?	Queries all settings related to arming.	8-29
:SAMPle:ARMinG:DElay:TIME	Sets the arming delay time or queries the current setting.	8-29
:SAMPle:ARMinG:SLOPe	Sets the arming slope or queries the current setting.	8-30
:SAMPle:ARMinG:SOURce	Sets the arming source or queries the current setting.	8-30
:SAMPle:GATE?	Queries all settings related to the gate.	8-30
:SAMPle:GATE:MODE	Sets the gate mode or queries the current setting.	8-30
:SAMPle:GATE:TIME	Sets the gate time or queries the current setting.	8-30
:SAMPle:INHibit?	Queries all settings related to inhibit.	8-30
:SAMPle:INHibit:POLarity	Sets the polarity of inhibit or queries the current setting.	8-30
:SAMPle:INHibit:STATe	Turns ON/OFF inhibit or queries the current setting.	8-30
<b>SStart Group</b>		
:SStart	Executes single measurement.	8-30
<b>STARt Group</b>		
:STARt	Starts the measurement.	8-30
<b>STATus Group</b>		
:STATus?	Queries all settings related to the communication status.	8-31
:STATus:CONDition?	Queries the contents of the condition register.	8-31
:STATus:EESE	Sets the extended event enable register or queries the current setting.	8-31
:STATus:EESR?	Queries the content of the extended event register and clears the register.	8-31
:STATus:ERRor?	Queries the error code and message information.	8-31
:STATus:FILTer?	Sets the transition filter or queries the current setting.	8-31
:STATus:QMESsage	Sets whether or not to attach message information to the response to the ":STATus:ERRor?" query or queries the current setting.	8-31
<b>STOP Group</b>		
:STOP	Stops the measurement.	8-32
<b>STORe Group</b>		
:STORe	Stores the setup information.	8-32

Command	Function	Page
<b>UNIT Group</b>		
:UNIT?	Queries the default unit of voltage and time.	8-33
:UNIT:TIME	Sets the default unit of time or queries the current setting.	8-33
:UNIT:VOLTage	Sets the default unit of voltage or queries the current setting.	8-33
<b>Common Command Group</b>		
*CAL?	Performs calibration and queries the result.	8-34
*CLS	Clears the standard event register, extended event register, and error queue.	8-34
*ESE	Sets the standard event enable register or queries the current setting.	8-34
*ESR?	Queries the standard event register and clears the register.	8-34
*IDN?	Queries the instrument model.	8-34
*OPC	Sets whether or not to clear the OPC event upon the completion of the specified overlap command.	8-34
*OPC?	Creates a response upon the completion of the specified overlap command.	8-34
*RST	Initializes the setup information.	8-35
*SRE	Sets the service request enable register or queries the current setting.	8-35
*STB?	Queries the status byte register.	8-35
*TRG	Executes single measurement.	8-35
*TST?	Performs a self-test and queries the result.	8-35
*WAI	Holds the subsequent command until the completion of the specified overlap operation.	8-35



### 8.7.2 CALCulation Group

The commands in this group deal with statistics. For details on setting the statistical equation, see the next page.

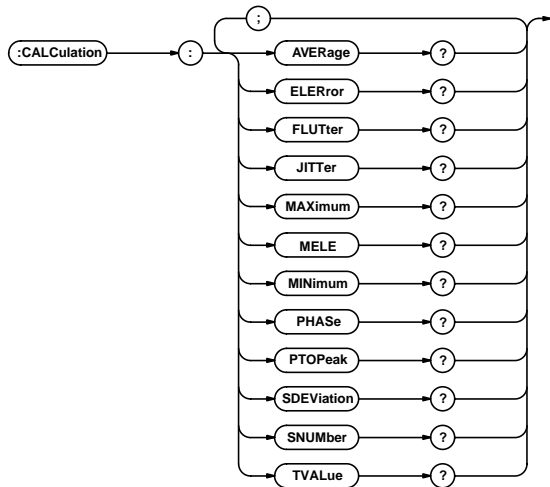

#### :CALCulation:AVERAge?

Function Queries the average value.  
 Syntax :CALCulation:AVERAge?  
 Example :CALCULATION:AVERAGE?→1.8542E-8  
 Description If the statistical value is not valid, "NAN" is returned.

#### :CALCulation:ELERror?

Function Queries the Effect Length Error.  
 Syntax :CALCulation:ELERror?  
 Example :CALCULATION:ELERROR→4.2E-11  
 Description If the statistical value is not valid, "NAN" is returned.

#### :CALCuIation:FLUTter?

Function Queries the  $\sigma$ /AVE value (flutter).  
 Syntax :CALCuIation:FLUTter?  
 Example :CALCULATION:FLUTTER?→1.5979E+1  
 Description If the statistical value is not valid, "NAN" is returned in response to a query.

#### :CALCulation:JITTer?

Function Queries the jitter ratio.  
 Syntax :CALCulation:JITTer?  
 Example :CALCULATION:JITTER?→8.008E+00  
 Description If the statistical value is not valid, "NAN" is returned.

#### :CALCulation:MAXimum?

Function Queries the maximum value.  
 Syntax :CALCulation:MAXimum?  
 Example :CALCULATION:MAXIMUM?→1.8967E-8  
 Description If the statistical value is not valid, "NAN" is returned.

#### :CALCuIation:MELE?

Function Queries the MELE value.  
 Syntax :CALCuIation:MELE?  
 Example :CALCULATION:MELE?→1.13E-1  
 Description If the statistical value is not valid, "NAN" is returned in response to a query.

#### :CALCulation:MINimum?

Function Queries the minimum value.  
 Syntax :CALCuIation:MINimum?  
 Example :CALCULATION:MINIMUM?→1.7945E-8  
 Description If the statistical value is not valid, "NAN" is returned.

#### :CALCulation:PHASe?

Function Queries the phase difference (in the range from 0 to 360°) between the data signal and the clock signal.  
 Syntax :CALCuIation:PHASe?  
 Example :CALCULATION:PHASE?→1.643E+2  
 Description If the statistical value is not valid or the measurement function is "D3T," "NAN" is returned.

#### :CALCulation:PTOPeak?

Function Queries the P-P value.  
 Syntax :CALCuIation:PTOPeak?  
 Example :CALCULATION:PTOPEAK?→1.022E-9  
 Description If the statistical value is not valid, "NAN" is returned.

#### :CALCulation:SDEVIation?

Function Queries the standard deviation (jitter  $\sigma$ ).  
 Syntax :CALCuIation:SDEVIation?  
 Example :CALCULATION:SDEVIATION?→2.963E-9  
 Description If the statistical value is not valid, "NAN" is returned.

**:CALCulation:SNUMber?**

**Function** Queries the number of samples (number of samples used to compute the statistics) of the data signal.

**Syntax** :CALCulation:SNUMber?

**Example** :CALCULATION:SNUMBER?→1.000E+3

**Description** If the statistical value is not valid, "NAN" is returned.

**:CALCulation:TVALue?**

**Function** Queries the period of the clock signal.

**Syntax** :CALCulation:TVALue?

**Example** :CALCULATION:TVALUE?→37.000E-9

**Description** The result of the query is as follows:

- If the measurement function is "DTC" and period T of the clock signal could be measured, the measured value is returned. If the statistical value is not valid, "NAN" is returned. If period T of the clock signal could not be measured, "37.000ns" is returned.
- If the measurement function is "D3T" and the statistical value is valid, the result derived from calculating "231.385 ns/xN speed" is returned. If the statistical value is not valid, "NAN" is returned. The ":MEASure:SPEed" command is used to set the xN speed.

**Equations Used to Derive Statistics**

In the equation below, n is the number of bins in the histogram. A bin of a histogram refers to a bar that indicates the frequency of occurrence on the histogram.  $X_i$  is the class value of each bin of the histogram. Of the following items, only the jitter and jitter ratio can be indicated on the analog meter and display:

- **Maximum value (MAX)**

Indicates the maximum class value.

$$\text{MAX} = [X_i]_{\text{max}}$$

- **Minimum value (MIN)**

Indicates the minimum class value.

$$\text{MIN} = [X_i]_{\text{min}}$$

- **Average value (AVE)**

Computes the average value.  $P_i$  is the relative frequency\*.

$$\text{AVE} = \sum_{i=1}^n X_i \times P_i$$

\* If the total number of samples on which the statistics are being calculated is N, and the frequency of occurrence (number of samples) of a certain bin is  $N_i$ , then the relative frequency becomes  $P_i = N_i/N$ .

- **Standard deviation (jitter  $\sigma$ )**

Computes the standard deviation.  $P_i$  is the relative frequency.

$$\sigma = \sqrt{\sum_{i=1}^n \{(X_i - \text{AVE})^2 \times P_i\}}$$

- **Peak-to-Peak (P-P)**

Calculates the difference between the maximum and minimum values.

$$\text{P-P} = \text{MAX} - \text{MIN}$$

- **Flutter ( $\sigma/\text{AVE}$ )**

Computes the flutter. Indicates the standard deviation as a ratio with respect to the average value.

$$\sigma / \text{AVE} = \frac{\sigma}{\text{AVE}} \times 100(\%)$$

- **Jitter ratio ( $\sigma/T$ )**

Computes the jitter ratio by using period T of the clock signal. T is the period of the clock signal of the CD or DVD. When the measurement function is 3T jitter,  $T = 231.385/N$  (where N is the multi-speed value). When the measurement function is D-to-C jitter, T is the period of the clock signal that is applied to the clock input connector or regenerated by the PLL circuit.

$$\sigma / T = \frac{\sigma}{T} \times 100(\%)$$

- **ELError (Effect Length Error)**

XCENTER is the center value of the histogram. Originally, XCENTER represented the value around which the measured data would be distributed. ELError indicates the offset of the actually measured average value AVE with respect to the XCENTER value.

For D-to-C jitter

$$X_{\text{CENTER}} = \frac{T}{2}$$

For 3T jitter

$$X_{\text{CENTER}} = 3T$$

T is the same as the T of the aforementioned "Jitter ratio ( $\sigma/T$ )."

$$\text{ELError} = \text{AVE} - X_{\text{CENTER}}$$

- **MELE (Maximum Effect Length Error)**

Computes the MELE using period T of the clock signal. MELE is indicated as a ratio with respect to T of ELError. For information on T, see "Jitter ratio ( $\sigma/T$ )."

$$\text{MELE} = \frac{|\text{AVE} - X_{\text{CENTER}}|}{T} \times 100(\%)$$

### 8.7.3 COMMunicate Group

The commands in this group deal with communications.

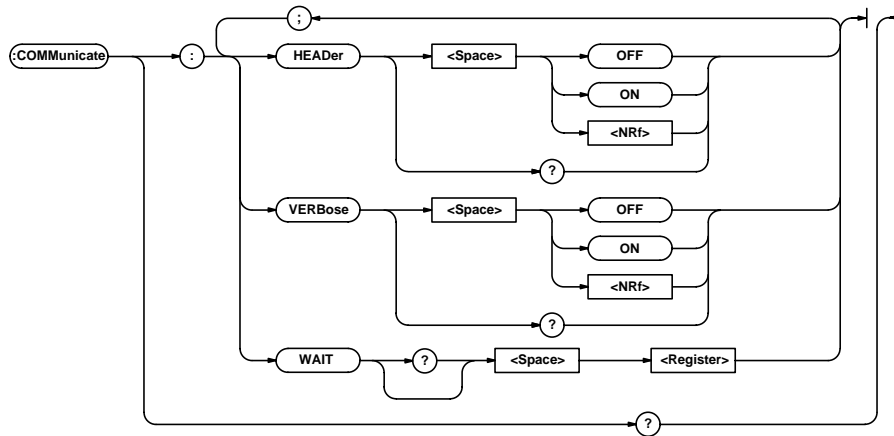

#### **:COMMunicate?**

Function Queries all settings related to communications.  
 Syntax :COMMunicate?  
 Example :COMMUNICATE?→:COMMUNICATE:HEADER 1;  
 VERBOSE 1

#### **:COMMunicate:HEADer**

Function Sets whether or not to attach a header to the response data or queries the current setting (ON/OFF).  
 Syntax :COMMunicate:HEADer <Boolean>  
 :COMMunicate:HEADer?  
 Example :COMMUNICATE:HEADer ON  
 :COMMUNICATE:HEADer?→:COMMUNICATE:  
 HEADer 1

#### **:COMMunicate:VERBose**

Function Sets the response messages to full form or abbreviated form or queries the current setting.  
 Syntax :COMMunicate:VERBose <Boolean>  
 :COMMunicate:VERBose?  
 Example :COMMUNICATE:VERBOSE OFF  
 :COMMUNICATE:VERBOSE?:COMMUNICATE:  
 VERBOSE 0

#### **:COMMunicate:WAIT**

Function Waits for one of the specified extended events to occur.  
 Syntax :COMMunicate:WAIT <Register>  
 <Register>=0 to 65535  
 Example :COMMUNICATE:WAIT 65535

#### **:COMMunicate:WAIT?**

Function Creates the response that is returned when the specified event occurs.  
 Syntax :COMMunicate:WAIT? <Register>  
 <Register>=0 to 65535  
 Example :COMMUNICATE:WAIT? 65535→1

### 8.7.4 DCOut Group

The commands in this group deal with DC output of the jitter ratio.

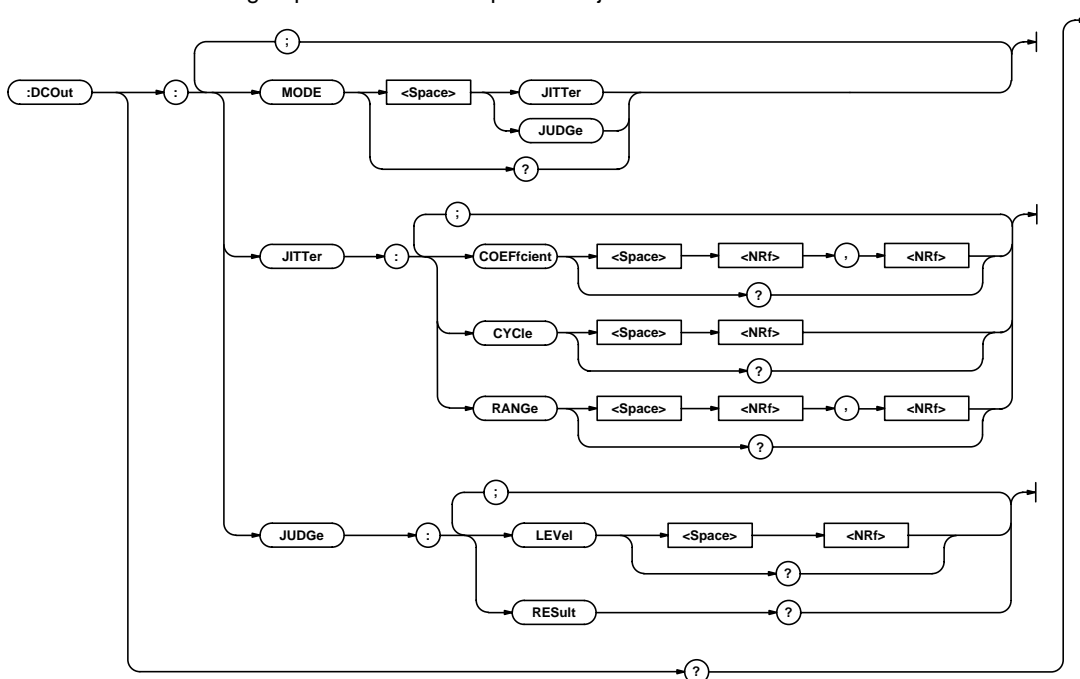

#### :DCOut?

**Function** Queries all settings related to the DC output of the jitter ratio.

**Syntax** :DCOut?

**Example** :DCOUT?→:DCOUT:MODE JITTER

#### :DCOut:JITTER:COEFFICIENT

**Function** Sets the jitter ratio correction coefficient or queries the current setting.

**Syntax** :DCOut:JITTER:COEFFICIENT <Nrf>,<Nrf>  
:DCOut:JITTER:COEFFICIENT?

First parameter<Nrf>=0.0001 to 9.9999(in 0.0001 steps)

Second parameter<Nrf>=-9.999 to 9.999(in 0.001 steps)

The first parameter is correction coefficient  $\alpha$ , the second parameter is correction coefficient  $\beta$ , respectively.

**Example** :DCOUT:JITTER:COEFFICIENT 1.2500,0.100  
:DCOUT:JITTER:COEFFICIENT?→1.2500E+00,  
0.001E+02

#### :DCOut:JITTER:CYCLE

**Function** Sets the average coefficient (number of measured values to be averaged) of the DC output of the jitter ratio or queries the current setting.

**Syntax** :DCOut:JITTER:CYCLE <Nrf>  
:DCOut:JITTER:CYCLE?  
<Nrf>=1 to 10 (in 1 steps)

**Example** :DCOUT:JITTER:CYCLE 1  
:DCOUT:JITTER:CYCLE?→1

**Description** This command can be used only when the DC output mode is set to "JITTER."

#### :DCOut:JITTER:RANGE

**Function** Sets the upper and lower limits of the DC output of the jitter ratio or queries the current setting.

**Syntax** :DCOut:JITTER:RANGE <Nrf>,<Nrf>  
:DCOut:JITTER:RANGE?

First parameter <Nrf>=0.00% to 25.00% (in 0.01% steps)

Second parameter <Nrf>=0.00% to 25.00% (in 0.01% steps)

The first and second parameters are upper and lower limits, respectively.

If the upper limit is less than or equal to the lower limit, an error occurs.

**Example** :DCOUT:JITTER:RANGE 25.00,0.00

:DCOUT:JITTER:RANGE?→25.00E+00,0.00E+00

**Description** This command can be used only when the DC output mode is set to "JITTER."

#### :DCOut:JUDGE:LEVEL

**Function** Sets the determination level or queries the current setting.

**Syntax** :DCOut:JUDGE:LEVEL {<Nrf>}  
:DCOut:JUDGE:LEVEL?  
<Nrf>=0.00% to 25.00% (in 0.01% steps)

**Example** :DCOUT:JUDGE:LEVEL 10.00  
:DCOUT:JUDGE:LEVEL?→10.00E+00

**Description** This command can be used only when the DC output mode is set to "JUDGE."

## 8.7 Commands

### **:DCOut:JUDGe:RESuLt?**

Function Queries the determination result.

Syntax :DCOut:JUDGe:RESuLt?

Example :DCOUT:JUDGE:RESULT?→GO

Description This command can be used only when the DC output mode is set to "JUDGe."

- If the result is GO, "GO" is returned.
- If the result is NOGO, "NOGO" is returned.
- If the result is NOJUDGE, "NOJUD" is returned.
- If the PLL is turned ON, determination cannot be performed until the clock signal is regenerated from the data signal. If the clock signal cannot be regenerated, "NOJUD" is returned.

### **:DCOut:MODE**

Function Sets the DC output mode or queries the current setting.

Syntax :DCOut:MODE {JITTer|JUDGe}

Example :DCOUT:MODE JITTER  
:DCOUT:MODE?→:DCOUT:MODE JITTER

## 8.7.5 DISPlay Group

The commands in this group deal with the display.

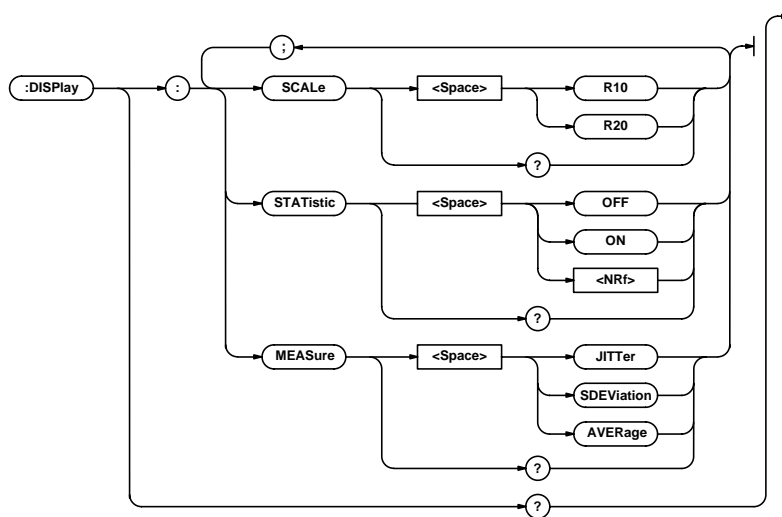

### **:DISPlay?**

Function Queries all settings related to the display.

Syntax :DISPlay?

Example :DISPLAY?→:DISPLAY:SCALE R10;  
STATISTIC 1;UNIT NS

### **:DISPlay:MEASure**

Function Sets the measured value to displayed or queries the current setting.

Syntax :DISPlay:MEASure {JITTer|SDEViation|  
AVERage}

Example :DISPLAY:MEASURE JITTER  
:DISPLAY:MEASURE→:DISPLAY MEASURE JITTER

### **:DISPlay:SCALe**

Function Sets the scale of the analog meter or queries the current setting.

Syntax :DISPlay:SCALe {R10|R20}

Example :DISPLAY:SCALE R10  
:DISPLAY:SCALE?→:DISPLAY:SCALE R10

### **:DISPlay:STATistic**

Function Turns ON/OFF the numeric display or queries the current setting.

Syntax :DISPlay:STATistic {Boolean}

Example :DISPLAY:STATISTIC ON  
:DISPLAY:STATISTIC?→:DISPLAY:STATISTIC 1

### 8.7.6 INPut Group

The commands in this group deal with the input signal.

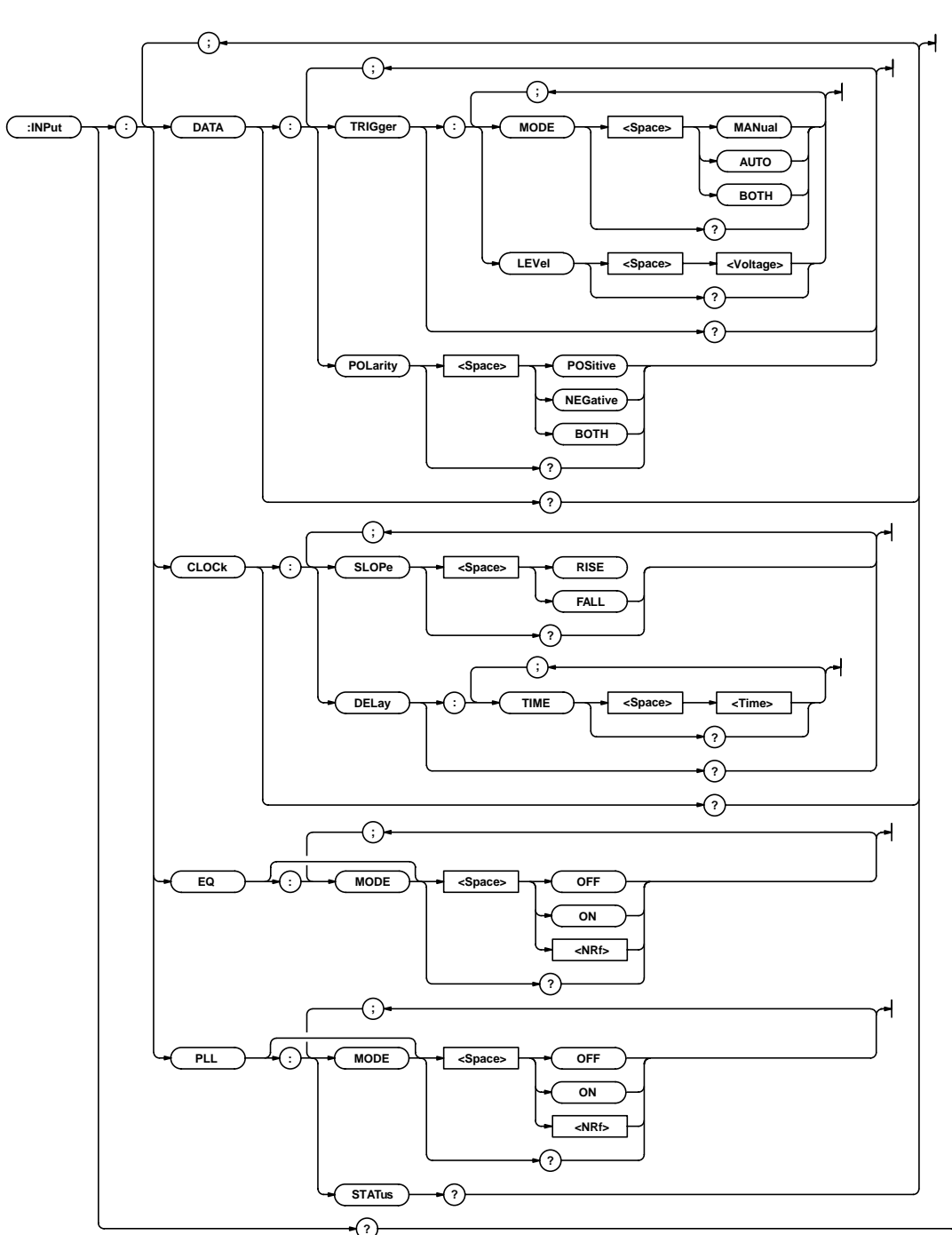

## 8.7 Commands

### **:INPut?**

Function Queries all settings related to the input signal.  
Syntax :INPut?  
Example :INPUT?→:INPUT:DATA:TRIGGER:MODE AUTO;  
INPUT:DATA:POLARITY POSITIVE;CLOCK:  
SLOPE POSITIVE;CLOCK:DELAY:  
TIME 10.0E-09;EQ 0;PLL 0

### **:INPut:CLOCK?**

Function Queries all settings related to the clock signal input.  
Syntax :INPut:CLOCK?  
Example :INPUT:CLOCK?→:INPUT:CLOCK:SLOPE RISE  
Description This command can be used only when the measurement function is set to "DTC."

### **:INPut:CLOCK:DELay?**

Function Queries all settings related to the phase delay of the clock signal.  
Syntax :INPut:CLOCK:DELay?  
Example :INPUT:CLOCK:DELAY?→:INPUT:CLOCK:DELAY;;  
TIME 10.0E-09  
Description This command can be used only when the measurement function is set to "DTC."

### **:INPut:CLOCK:DELay:TIME**

Function Sets the phase delay time of the clock signal or queries the current setting.  
Syntax :INPut:CLOCK:DELay:TIME <Time>  
:INPut:CLOCK:DELay:TIME?  
<Time>=0.0 ns to 40.0 ns (in 0.1 ns steps)  
Example :INPUT:CLOCK:DELAY:TIME 10NS  
:INPUT:CLOCK:DELAY:TIME?→:INPUT:CLOCK:  
DELAY:TIME 10.0E-09  
Description This command can be used only when the measurement function is set to "DTC."

### **:INPut:CLOCK:SLOPe**

Function Sets the slope of the clock signal or queries the current setting.  
Syntax :INPut:CLOCK:SLOPe {RISE|FALL}  
INPut:CLOCK:SLOPe?  
Example :INPUT:CLOCK:SLOPE RISE  
:INPUT:CLOCK:SLOPE?→:INPUT:CLOCK:  
SLOPE RISE  
Description This command can be used only when the measurement function is set to "DTC."

### **:INPut:DATA:POLarity**

Function Sets the polarity of the data signal or queries the current setting.  
Syntax :INPut:DATA:POLarity {Positive|NEGative|  
BOTH}  
:INPut:DATA:POLarity?  
Example :INPUT:DATA:POLARITY POSITIVE  
:INPUT:DATA:POLARITY?→:INPUT:DATA:  
POLARITY POSITIVE  
Description When the measurement function is "D3T," "BOTH" cannot be specified.

### **:INPut:DATA:TRIGger?**

Function Queries all settings related to the trigger.  
Syntax :INPut:DATA:TRIGger?  
Example :INPUT:DATA:TRIGGER?→:INPUT:DATA:TRIGGER:  
MODE AUTO;POLARITY POSITIVE

### **:INPut:DATA:TRIGger:MODE**

Function Sets the trigger mode or queries the current setting.  
Syntax :INPut:DATA:TRIGger:MODE {AUTO|MANual|  
BOTH}  
:INPut:DATA:TRIGger:MODE?  
Example :INPUT:DATA:TRIGGER:MODE AUTO  
:INPUT:DATA:TRIGGER:MODE?→:INPUT:DATA:  
TRIGGER:MODE AUTO

### **:INPut:DATA:TRIGger:LEVel**

Function Sets the slice level or queries the current setting.  
Syntax :INPut:DATA:TRIGger:LEVel <Voltage>  
:INPut:DATA:TRIGger:LEVel?  
(When TriggerMode = MANUAL)  
• When the equalizer is OFF  
<Voltage> = -5.000 V to 5.000 V (in 1 mV steps)  
• When the equalizer is ON  
<Voltage> = -1.000 V to 1.000 V (in 1 mV steps)  
(When TriggerMode = BOTH)  
<Voltage> = -1.000 V to 1.000 V (in 1 mV steps)  
Example :INPUT:DATA:TRIGGER:LEVEL 1V  
:INPUT:DATA:TRIGGER:LEVEL?→:INPUT:DATA:  
TRIGGER:LEVEL 1.000E+00  
Description • You can set or query the slice level when the trigger mode is "MANual" or "BOTH."  
• The slice levels for "MANual" and "BOTH" are stored separately.

### **:INPut:EQ[:MODE]**

Function Turns ON/OFF the equalizer or queries the current setting.  
Syntax :INPut:EQ[:MODE] {Boolean}  
:INPut:EQ[:MODE]?  
Example :INPUT:EQ:MODE ON  
:INPUT:EQ:MODE?→:INPUT:EQ:MODE 1

**:INPut:PLL[:MODE]**

Function Sets the PLL or queries the current setting.

Syntax :INPut:PLL[:MODE] {Boolean}  
:INPut:PLL[:MODE]?

Example :INPUT:PLL:MODE ON  
:INPUT:PLL:MODE?→:INPUT:PLL:MODE 1

Description You can set or query the PLL only when the measurement function is set to "DTCO."

**:INPut:PLL:STATUS?**

Function Queries the lock condition (when the clock signal could be regenerated from the data signal) of the PLL.

Syntax :INPut:PLL:STATUS?

Example :INPUT:PLL:STATUS?→:INPUT:PLL:STATUS LOCK

Description You can query the PLL only when the measurement function is set to "DTCO" and the PLL is "ON."

- When not locked: UNLOCK is returned.
- When locked: LOCK is returned.

**8.7.7 MEASure Group**

The commands in this group deal with measurement conditions.

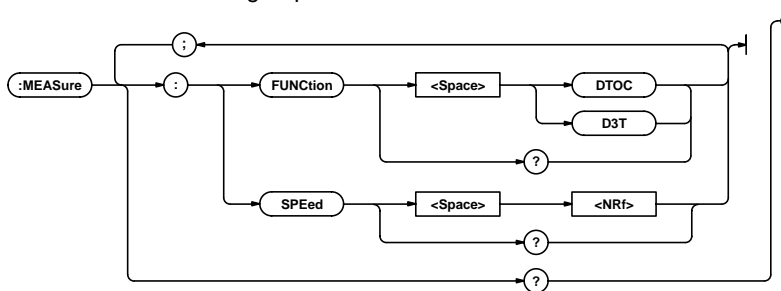
**:MEASure?**

Function Queries all settings related to the measurement.

Syntax :MEASure?

Example :MEASURE?→:MEASURE:FUNCTION DTCO

**:MEASure:FUNCTION**

Function Sets the measurement function or queries the current setting.

Syntax :MEASure:FUNCTION {DTCO|D3T}  
:MEASure:FUNCTION?

Example :MEASURE:FUNCTION DTCO  
:MEASURE:FUNCTION?→:MEASURE:FUNCTION DTCO

**:MEASure:SPEEd**

Function Sets the xN speed or queries the current setting.

Syntax :MEASure:SPEEd <NRf>  
:MEASure:SPEEd?

<NRf>=1.0 to 10.0  
Example :MEASURE:SPEED 1.0  
:MEASURE:SPEED?→:MEASURE:SPEED 1.0E+00

Description This command can be used only when the measurement function is set to "D3T."



### 8.7.8 MEMory Group

The commands in this group deal with the external transmission of the measured data. The raw data that has been measured is externally transmitted in ASCII or binary format. For a detailed description of this function, see the next page.

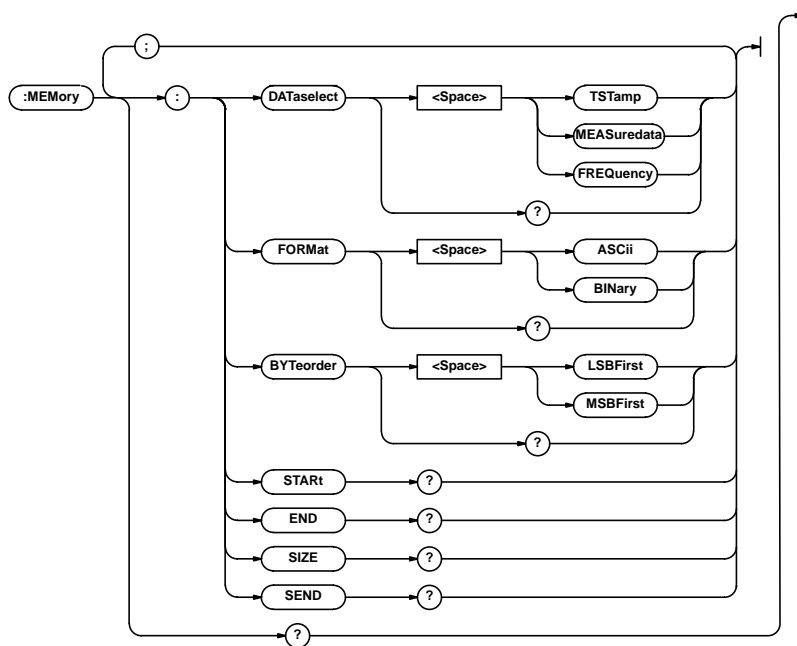

#### :MEMory?

**Function** Queries all settings related the external transmission of the measured data.

**Syntax** :MEMory?

**Example** :MEMORY?→:MEMORY:DATASELECT FREQUENCY;  
FORMAT ASCII;BYTEORDER LSBFIRST

#### :MEMory:BYTeorder

**Function** Sets the transmission order of binary data or queries the current setting.

**Syntax** :MEMory:BYTeorder {LSBFirst|MSBFirst}  
:MEMory:BYTeorder?

**Example** :MEMORY:BYTEORDER LSBFIRST  
:MEMORY:BYTEORDER?→:MEMORY:  
BYTEORDER LSBFIRST

#### :MEMory:DATaselect

**Function** Sets the data to be transmitted or queries the current setting.

**Syntax** :MEMory:DATaselect {TSTamp|MEASuredata|FREQuency}  
:MEMory:DATaselect?

**Example** :MEMORY:DATASELECT FREQUENCY  
:MEMORY:DATASELECT?→:MEMORY:  
DATASELECT FREQUENCY

**Example** The transmitted data varies depending on the measurement function.

- When the measurement function is set to “DtC” or “3T”:  
MEASuredata (measured time data) and FREQuency (histogram frequency data)
- When the measurement function is set to “W0BB1e” (BI-PHASE measurement function option, see the TA120E Digital Jitter Meter Option Function User’s Manual (IM704420-51E)):  
TSTamp (measured time stamp) and MEASuredata (measured time data)

**:MEMory:END?**

Function	Queries the end position of the data to be transmitted.
Syntax	:MEMory:END?
Example	:MEMORY:END?→:MEMORY:END 37.0E-9<Time>
Example	You cannot make a query when the measurement function is set to "WOBBLe" (BI-PHASE measurement function option, see the TA120E Digital Jitter Meter Option Function User's Manual (IM704420-51E)).

**:MEMory:FORMat**

Function	Sets the format of the data to be transmitted or queries the current setting.
Syntax	:MEMory:FORMat {ASCIi BINary} :MEMory:FORMat?
Example	:MEMORY:FORMAT ASCII :MEMORY:FORMAT?→:MEMORY:FORMAT ASCII

**:MEMory:SEND?**

Function	Executes the transmission of the measured data specified by "MEMory:DATaselect."
Syntax	:MEMory:SEND?
Example	:MEMORY:SEND?→#8000000016abcdabcea
Example	(When the format is ASCII) <ul style="list-style-type: none"> <li>For measured time stamp and measure time data &lt;Time&gt;,&lt;Time&gt;.....</li> <li>For histogram frequency data &lt;NR1&gt;,&lt;NR1&gt;.....</li> </ul> (When the format is binary) #800100000ABCDEFGHJ <ul style="list-style-type: none"> <li>#8: Indicates that an 8-digit value follows.</li> <li>8-digit value 00100000: Indicates the number of transmitted data bytes. The number of transmitted bytes is 10000.</li> <li>ABCDEFGHJ.....: Indicates the actual number of data bytes.</li> </ul> Frequency (FREQuency): The frequency is stored using a 4-byte unsigned integer. Measured data (MEASuredata): 4-byte unsigned integer. The measured value is derived by multiplying the resolution below. DtoC, 3T: 312.5 ns BI-PHASE (option, see the TA120E Digital Jitter Meter Option Function User's Manual (IM704420-51E)): 156.25 ns Measured time stamp (TSTamp): 4-byte unsigned integer. The time stamp value is derived by multiplying 160.0 ns to this value.

**:MEMory:SIZE?**

Function	Queries the number of data points that have been measured.
Syntax	:MEMory:SIZE?
Example	:MEMORY:SIZE?→100000
Example	You can make a query only when the measurement function is set to "WOBBLe" (BI-PHASE measurement function option, see the TA120E Digital Jitter Meter Option Function User's Manual (IM704420-51E)).

**:MEMory:START?**

Function	Queries the start position of the data to be transmitted.
Syntax	:MEMory:START?
Example	:MEMORY:START?→:MEMORY:START 0.0E-9 <Time>
Example	You cannot make a query when the measurement function is set to "WOBBLe" (BI-PHASE measurement function option, see the TA120E Digital Jitter Meter Option Function User's Manual (IM704420-51E)).

**Transmitted Data**

The transmitted data varies depending on the measurement function.

- When the measurement function is set to D-to-C jitter or 3T jitter  
Measured time data and histogram frequency data
- When the measurement function is set to BI-PHASE (option, see the TA120E Digital Jitter Meter Option Function User's Manual (IM704420-51E))  
Measured time stamp and measured time data

**Transmitted Range**

All the data that the TA120E is computing within the window range are transmitted. The transmitted range varies depending on the measurement function as follows:

- When the measurement function is set to DtoCDVD:  
0 ns to T (T: the measured clock value when PLL is OFF, the regenerated clock value when PLL is ON)
- When the measurement function is set to 3TCD×N or 3TCD×N:  
2.5T to 3.5T (T: 231.385 ns/×N speed)
- When the measurement function is set to BI-PHASE (option, see the TA120E Digital Jitter Meter Option Function User's Manual (IM704420-51E)):  
Data corresponding to the number of samples acquired

**Note**

- Data cannot be transmitted while measurement is in progress. Data can only be transmitted after the measurement has finished.

### 8.7.9 RECall Group

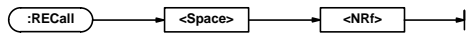

#### **:RECall**

Function Recalls the setup information.

Syntax :RECall <NRf>

<NRf>=0 to 6

Example :RECALL 1

Description To continue with measurements, use the START command after this command.

### 8.7.10 SAMPlE Group

The commands in this group deal with sampling conditions.

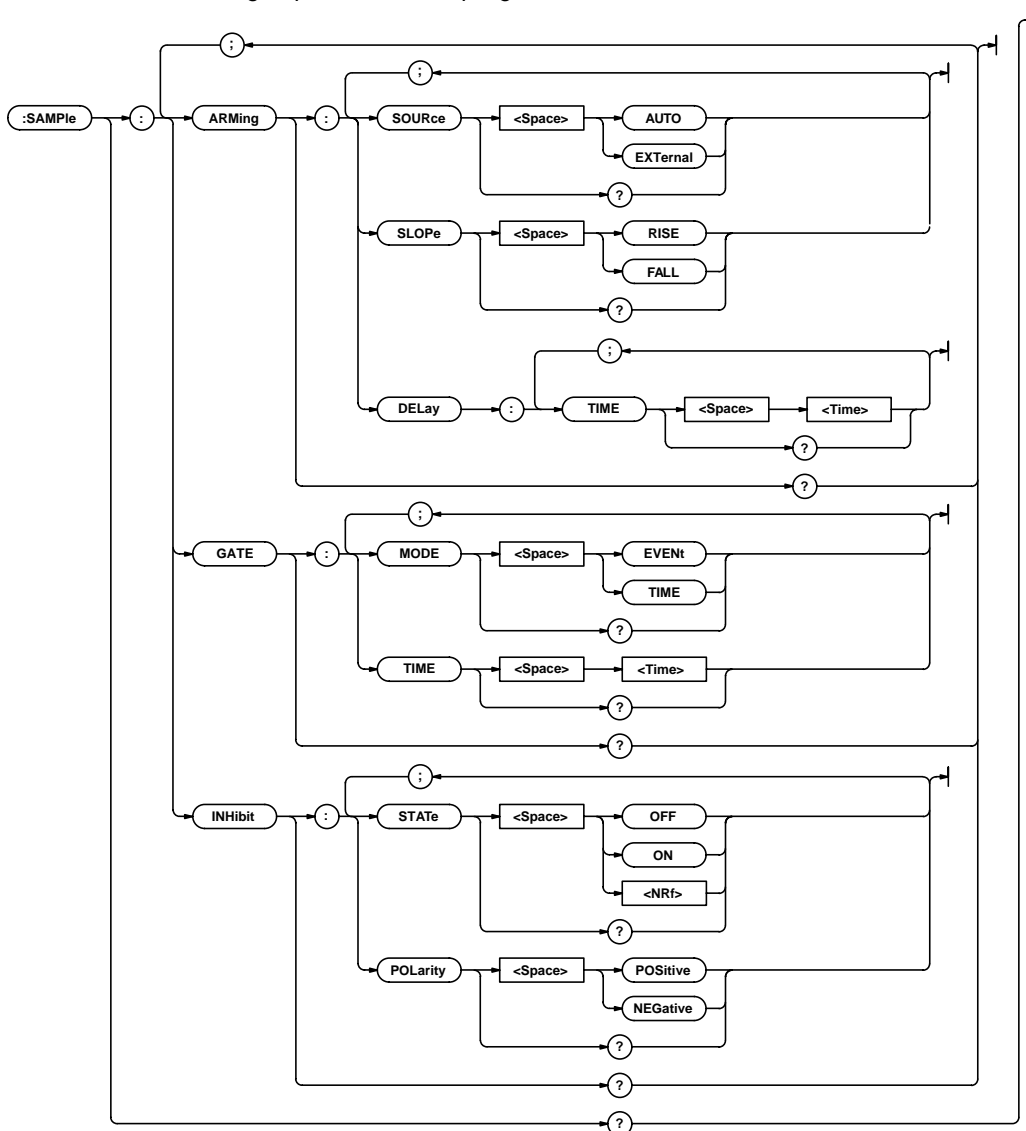

#### :SAMPle?

Function Queries all settings related to the acquisition of the input signal.

Syntax :SAMPle?

Example :SAMPle?→:SAMPle:ARMinG:SOURce AUTO;;  
SAMPle:GATE:MODE TIME;TIME 100.0E-03;;  
SAMPle:INHibit:STATE 0

#### :SAMPle:ARMinG?

Function Queries all settings related to arming.

Syntax :SAMPle:ARMinG?

Example :SAMPle:ARMinG?→:SAMPle:ARMinG:  
SOURce EXTERNAL;SLOPe RISE

#### :SAMPle:ARMinG:DELay:TIME

Function Sets the arming delay time or queries the current setting.

Syntax :SAMPle:ARMinG:DELay:TIME <Time>

:SAMPle:ARMinG:DELay:TIME?  
<Time>=0.0 ms to 1 s (in 0.1 ms steps)

Example :SAMPle:ARMinG:DELay:TIME 1MS

:SAMPle:ARMinG:DELay:TIME?→:SAMPle:  
ARMinG:DELay:TIME 1.0E-03

Description You can set or query the arming delay only when the arming mode is set to "EXTErnal."

## 8.7 Commands

### **:SAMPLE:ARMing:SLOPe**

Function Sets the arming slope or queries the current setting.

Syntax :SAMPLE:ARMing:SLOPe {RISE|FALL}  
:SAMPLE:ARMing:SLOPe?

Example :SAMPLE:ARMING:SLOPE RISE  
:SAMPLE:ARMING:SLOPE?→:SAMPLE:ARMING:SLOPE RISE

Description You can set or query the arming slope only when the arming source is set to "EXTernal."

### **:SAMPLE:ARMing:SOURce**

Function Sets the arming source or queries the current setting.

Syntax :SAMPLE:ARMing:SOURce {AUTO|EXTernal}  
:SAMPLE:ARMing:SOURce?

Example :SAMPLE:ARMING:SOURCE AUTO  
:SAMPLE:ARMING:SOURCE?→:SAMPLE:ARMING:SOURCE AUTO

### **:SAMPLE:GATE?**

Function Queries all settings related to the gate.

Syntax :SAMPLE:GATE?

Example :SAMPLE:GATE?→:SAMPLE:GATE:MODE TIME;  
TIME 1.000E+00

### **:SAMPLE:GATE:MODE**

Function Sets the gate mode or queries the current setting.

Syntax :SAMPLE:GATE:MODE {EVENT|TIME}  
:SAMPLE:GATE:MODE?

Example :SAMPLE:GATE:MODE EVENT  
:SAMPLE:GATE:MODE?→:SAMPLE:GATE:MODE EVENT

### **:SAMPLE:GATE:TIME**

Function Sets the gate time or queries the current setting.

Syntax :SAMPLE:GATE:TIME <Time>  
:SAMPLE:GATE:TIME?  
<Time>=0.1 ms to 1 s (in 0.1 ms steps)

Example :SAMPLE:GATE:TIME 1MS  
:SAMPLE:GATE:TIME?→:SAMPLE:GATE:TIME 100.0E-03

Description You can set or query the gate time only when the gate mode is set to "TIME."

### **:SAMPLE:INHibit?**

Function Queries all settings related to inhibit.

Syntax :SAMPLE:INHibit?

Example :SAMPLE:INHIBIT?→:SAMPLE:INHIBIT:STATE 1;  
POLARITY POSITIVE

### **:SAMPLE:INHibit:POLarity**

Function Sets the polarity of inhibit or queries the current setting.

Syntax :SAMPLE:INHibit:POLarity {POSitive|NETGative}  
:SAMPLE:INHibit?

Example :SAMPLE:INHIBIT:POLARITY POSITIVE  
:SAMPLE:INHIBIT:POLARITY?→:SAMPLE:INHIBIT:POLARITY POSITIVE

Description You can set the polarity of inhibit only when inhibit is turned "ON (enabled)" through the ":SAMPLE:INHibit:STATE" command.

### **:SAMPLE:INHibit:STATE**

Function Turns ON/OFF inhibit or queries the current setting.

Syntax :SAMPLE:INHibit:STATE {Boolean}  
:SAMPLE:INHibit?

Example :SAMPLE:INHIBIT:STATE ON  
:SAMPLE:INHIBIT:STATE?→:SAMPLE:INHIBIT:STATE 1

## 8.7.11 SStart Group



### **:SStart**

Function Executes the measurement once (single measurement).

Syntax :SStart

Example :SSTART

## 8.7.12 STARTt Group

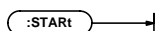

### **:STARTt**

Function Starts the measurement (continuous measurement).

Syntax :STARTt

Example :START

### 8.7.13 STATus Group

The commands in this group deal with communication status. For a status report, see section 8.8.

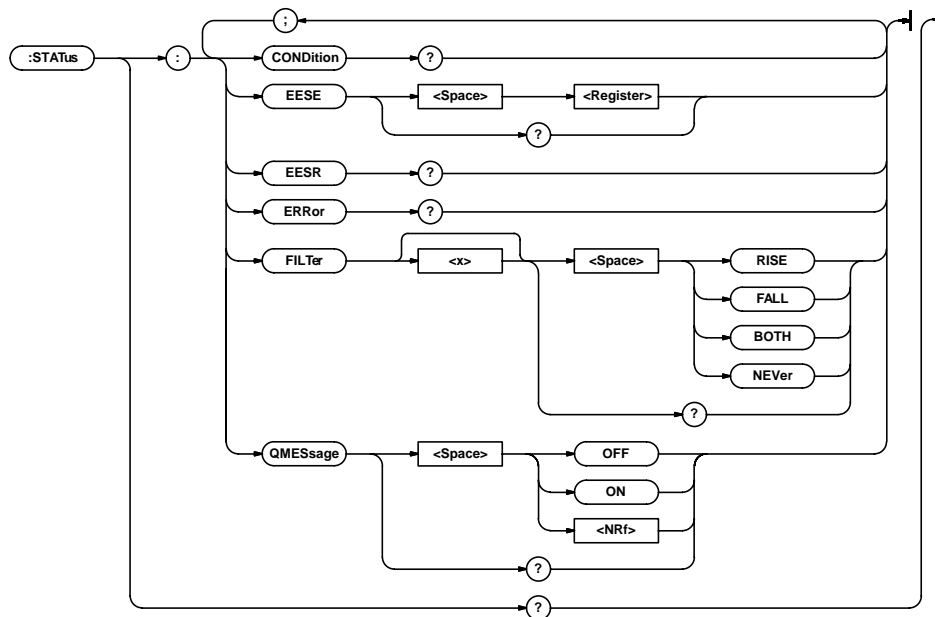

#### :STATus?

**Function** Queries all settings related to the communication status.

**Syntax** :STATus?

**Example** :STATus?→:STATus:EESr 0;FILTer1 RISE; FILTer2 NEVER;FILTer3 NEVER;FILTer4 NEVER; FILTer5 NEVER;FILTer6 NEVER;FILTer7 NEVER; FILTer8 NEVER;FILTer9 RISE;FILTer10 RISE; FILTer11 RISE;FILTer12 RISE;FILTer13 RISE; FILTer14 NEVER;FILTer15 NEVER; FILTer16 NEVER;QMESSage 1

#### :STATus:CONDition?

**Function** Queries the contents of the condition register.

**Syntax** :STATus:CONDition?

**Example** :STATus:CONDition?→16

#### :STATus:EESr

**Function** Sets the extended event enable register or queries the current setting.

**Syntax** :STATus:EESr <Register>  
STATus:EESr?  
<Register>=0 to 65535

**Example** :STATus:EESr 257  
:STATus:EESr?→:STATus:EESr 257

#### :STATus:EESR?

**Function** Queries the content of the extended event register and clears the register.

**Syntax** :STATus:EESR?

**Example** :STATus:EESR?→1

#### :STATus:ERRor?

**Function** Queries the error code and message information (top of the error queue).

**Syntax** :STATus:ERRor?

**Example** :STATus:ERRor?→113,"Undefined header"

#### :STATus:FILTer<x>

**Function** Sets the transition filter or queries the current setting.

**Syntax** :STATus:FILTer<x> {RISE|FALL|BOTH|NEVer}  
STATus:FILTer<x>?  
<x>=1 to 16

**Example** :STATus:FILTer2 RISE  
:STATus:FILTer2?→:STATus:FILTer2 RISE

#### :STATus:QMESSage

**Function** Sets whether or not to attach message information to the response to the ":STATus:ERRor?" query or queries the current setting.

**Syntax** :STATus:QMESSage <BooLean>  
STATus:QMESSage?

**Example** :STATus:QMESSage OFF  
:STATus:QMESSage?→:STATus:QMESSage 0

## 8.7 Commands

---

### 8.7.14 STOP Group



#### **:STOP**

Function Stops the measurement.

Syntax :STOP

Example :STOP

### 8.7.15 STORE Group

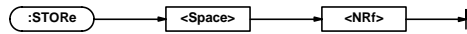

#### **:STORE**

Function Stores the setup information.

Syntax :STORE <NRf>

<NRf>=0 to 6

Example :STORE 1

### 8.7.16 UNIT Group

The commands in this group deal with the default unit of voltage and time.

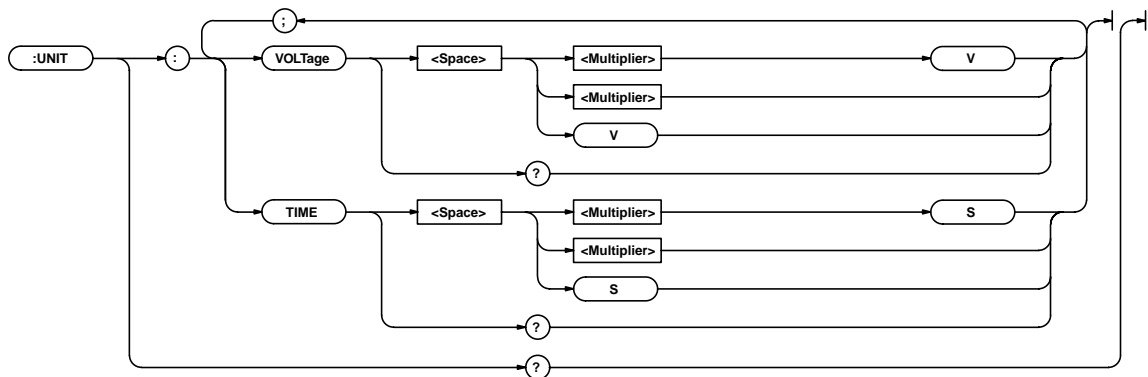

#### **:UNIT?**

Function Queries the default unit of the voltage and time.

Syntax :UNIT?

Example :UNIT?→:UNIT:VOLTAGE V;TIME S

#### **:UNIT:TIME**

Function Sets the default unit of time or queries the current setting.

Syntax :UNIT:TIME <Multiplier>S  
:UNIT:TIME?

<Multiplier>= See the description below.

Example :UNIT:TIME MS

:UNIT:TIME?→:UNIT:TIME MS

Description The following multipliers can be specified:

EX : Exa ( $10^{18}$ )  
PE : Peta ( $10^{15}$ )  
T : Tera ( $10^{12}$ )  
G : Giga ( $10^9$ )  
MA : Mega ( $10^6$ )  
K : Kilo ( $10^3$ )  
M : Milli ( $10^{-3}$ )  
U : Micro ( $10^{-6}$ )  
N : Nano ( $10^{-9}$ )  
P : Pico ( $10^{-12}$ )  
F : Femto ( $10^{-15}$ )  
A : Ato ( $10^{-18}$ )

#### **:UNIT:VOLTage**

Function Sets the default unit of voltage or queries the current setting.

Syntax :UNIT:VOLTage <Multiplier>V  
:UNIT:VOLTage?

<Multiplier>= See the description of the default unit setting of time (:UNIT:TIME).

Example :UNIT:VOLTAGE MV

:UNIT:VOLTAGE?→:UNIT:VOLTAGE MV



### 8.7.17 Common Command Group

The commands in the common group are defined in the IEEE 488.2-1992 and are independent of the instrument's functions.

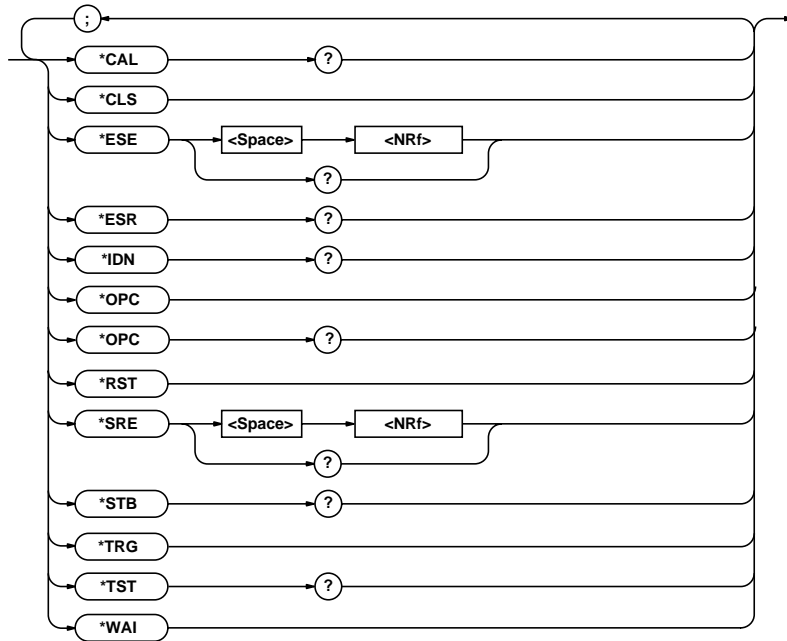

**\*CAL?**

**Function** Performs calibration and queries the result.  
**Syntax** \*CAL?  
**Example** \*CAL?  
**Description** If the calibration terminates normally, "0" is returned. If abnormality is detected, a non-zero value is returned. There is another calibration execution command. For details, see page 9-12.

**\*CLS**

**Function** Clears the standard event register, extended event register, and error queue.  
**Syntax** \*CLS  
**Example** \*CLS  
**Description** For details on the standard event register, extended event register, and error queue, see section 8.8, "Status Report."

**\*ESE**

**Function** Sets the standard event enable register or queries the current setting.  
**Syntax** \*ESE <NRf>  
 \*ESE?  
 <NRf>=0 to 255  
**Example** \*ESE 253  
 \*ESE?→253  
**Description** For details on the standard event enable register, see section 8.8, "Status Report."

**\*ESR?**

**Function** Queries the standard event register and clears the register.  
**Syntax** \*ESR?  
**Example** \*ESR?→253  
**Description** For details on the standard event register, see section 8.8, "Status Report."

**\*IDN?**

**Function** Queries the instrument model.  
**Syntax** \*IDN?  
**Example** \*IDN?→YOKOGAWA,704420,0,F1.01  
**Description** A reply is returned in the following form: manufacturer, model, serial number (always 0), firmware version.

**\*OPC**

**Function** Sets a "1" to the standard event register bit upon the completion of the specified overlap command. Because the instrument does not support overlap commands, the command is discarded.  
**Syntax** \*OPC

**\*OPC?**

**Function** Returns a "1" when the specified overlap command is finished. A "1" is always returned, because the instrument does not support overlap commands.  
**Syntax** \*OPC?

**\*RST**

Function Initializes the setup information.  
 Syntax \*RST  
 Example \*RST  
 Description For details on initialization, see section 7.4. The GP-IB address is not initialized.

**\*SRE**

Function Sets the service request enable register or queries the current setting.  
 Syntax \*SRE <NRf>  
 \*SRE?  
 <NRf>=0 to 255  
 Example \*SRE 239  
 \*SRE?→239

**\*STB?**

Function Queries the status byte register.  
 Syntax \*STB?  
 Example \*STB?→4  
 Description For details on the status byte register, see section 8.8, "Status Report."

**\*TRG**

Function Executes single measurement.  
 Syntax \*TRG  
 Description The multi-line message GET (Group Execute Trigger) also performs the same operation as this command.

**\*TST?**

Function Performs a self-test and queries the result.  
 Syntax \*TST?  
 Example \*TST?→0  
 Description If all the tests terminate normally, a "0" is returned. If abnormality is detected, a non-zero code is returned.

**\*WAI**

Function Holds the subsequent command until the completion of the specified overlap operation. Because the instrument does not support overlap commands, the command is discarded.  
 Syntax \*WAI

# 8.8 Status Report

## 8.8.1 About the Status Report

### Status Report

The figure shows the status report that is read by serial polling. This status report is an extended version of the status report defined in IEEE 488.2-1992.

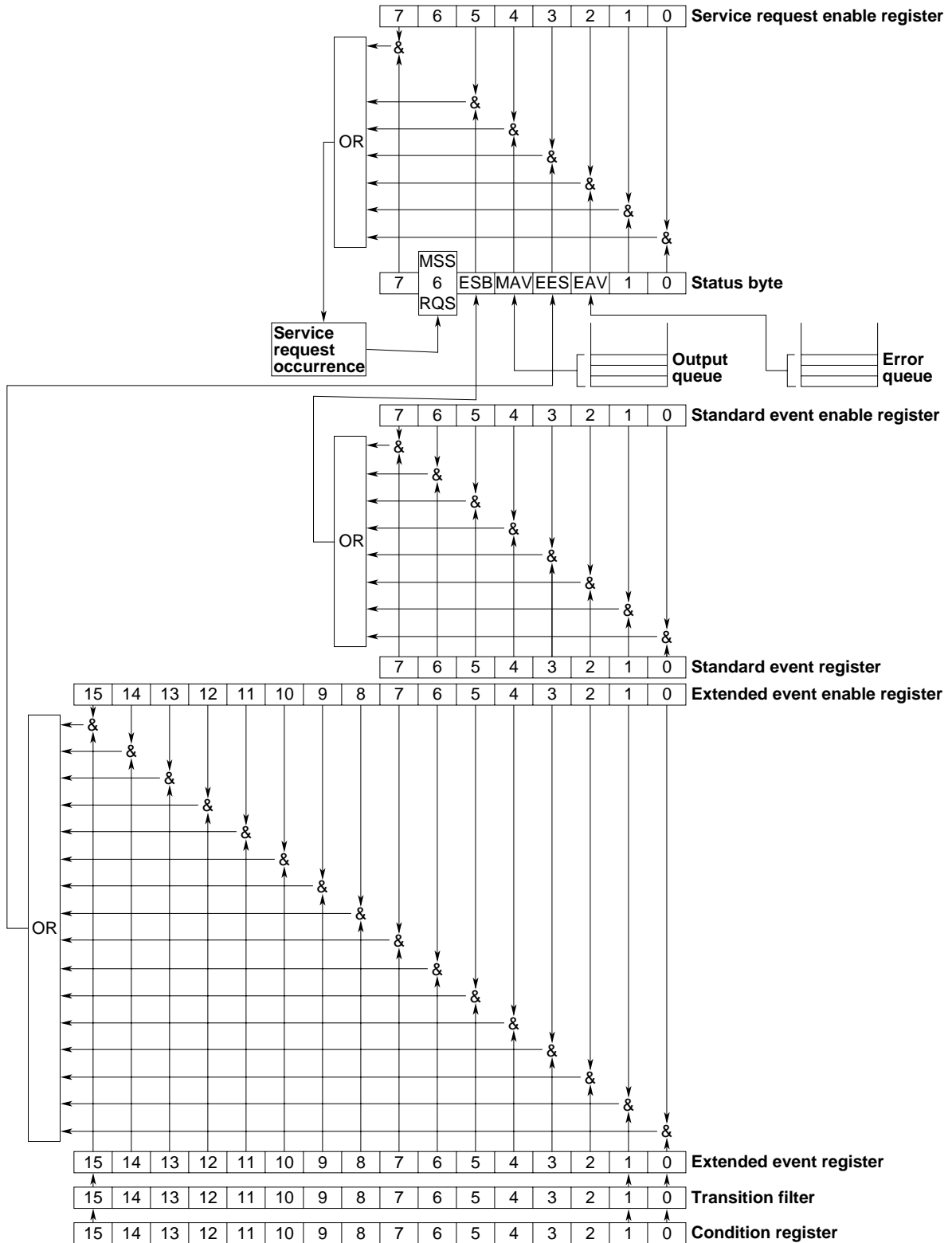

## Summary of the Registers and Queues

Name (Function)	Write	Read
Status byte	—	Serial polling (RQS), *STB?(MSS)
Service request enable register (Status byte mask)	*SRE	*SRE?
Standard event register (Changes in device status)	—	*ESR?
Standard event enable register (Standard event register mask)	*ESE	*ESE?
Extended event register (Changes in device status)	—	STATUS:EESR?
Extended event enable register (Extended event register mask)	STATUS:EESE	STATUS:EESE?
Condition register (Current device status)	—	STATUS:CONDition?
Transition filter (Conditions that change the extended event register)	STATUS:FILTer<x>	STATUS:FILTer<x>?
Output queue (Stores a response message to a query)	All query commands	
Error queue (Stores the error No. and message)	—	STATUS:ERRor?

## Registers and Queues That Affect the Status Byte

Registers that affect the bits of the status byte are shown below.

- Standard event register: Sets bit 5 (ESB) of the status byte to “1” or “0.”
- Output queue: Sets bit 4 (MAV) of the status byte to “1” or “0.”
- Extended event register: Sets bit 3 (EES) of the status byte to “1” or “0.”
- Error queue: Sets bit 2 (EAV) of the status byte to “1” or “0.”

## Enable Registers

Registers that are used to mask a bit so that the bit will not affect the status byte, even if it is set to 1, are shown below.

- Status byte: Mask the bits using the service request enable register.
- Standard event register: Mask the bits using the standard event enable register.
- Extended event register: Mask the bits using the extended event enable register.

## Reading and Writing to the Registers

For example, the \*ESE command is used to set the bits in the standard event register to 1s or 0s. The \*ESE? command is used to query whether the bits in the standard event register are 1s or 0s. For details regarding these commands, see section 8.7.

## 8.8.2 Status Byte

### Status Byte



### Bits 0, 1, and 7

Not used (always 0)

### Bit 2 EAV (Error Available)

Set to “1” when the error queue is not empty. In other words, this bit is set to “1” when an error occurs. See the page 8-40.

### Bit 3 EES (Extend Event Summary Bit)

Set to “1” when the logical product of the extended event register and the corresponding event register is “1.” In other words, this bit is set to “1” when an event occurs inside the instrument. See the page 8-39.

### Bit 4 MAV (Message Available)

Set to “1” when the output queue is not empty. In other words, this bit is set to “1” when there are data to be transmitted. See the page 8-40.

### Bit 5 ESB (Event Summary Bit)

Set to “1” when the logical product of the standard event register and the corresponding event register is “1.” In other words, this bit is set to “1” when an event occurs inside the instrument. See the page 8-38.

### Bit 6 RQS (Request Service)/MSS (Master Status Summary)

Set to “1” when the logical AND of the status byte excluding Bit 6 and the service request enable register is not “0.” In other words, this bit is set to “1” when the instrument is requesting service from the controller.

RQS is set to “1” when the MSS bit changes from “0” to “1,” and cleared when serial polling is carried out or when the MSS bit changes to “0.”

### Bit Masking

If you wish to mask a certain bit of the status byte so that it does not cause an SRQ, set the corresponding bit of the service request enable register to “0.”

For example, to mask bit 2 (EAV) so that service is not requested when an error occurs, set bit 2 of the service request enable register to “0.” This is done using the \*SRE command. The \*SRE? request command can be used to query the service request enable register to check whether each bit is set to “1” or “0.” For details on the \*SRE command, see section 8.7.

## 8.8 Status Report

### Status Byte Operation

A service request is issued when bit 6 of the status byte becomes a "1." Bit 6 is set to "1" when any of the other bits becomes a "1" (when the corresponding bit of the service request enable register is also set to "1"). For example, if an event occurs and the logical AND of the standard event register and the corresponding enable register becomes a "1", then bit 5 (ESB) is set to "1." At this point, if bit 5 of the service request enable register is "1," then bit 6 (MSS) is set to "1" causing the instrument to request service from the controller.

In addition, you can also check what type of event occurred by reading the contents of the status byte.

### Reading the Status Byte

The following two methods are available in reading the contents of the status byte.

#### Query using the \*STB? command

An \*STB? query causes bit 6 to be a MSS bit. Therefore, the MSS bit is read. No bits in the status byte are cleared after reading the status byte.

#### Serial polling

Serial polling causes bit 6 to be a RQS bit. Therefore, the RQS bit is read. After reading the status byte, only the RQS bit is cleared. You cannot read the MSS bit when serial polling is used.

### Clearing the Status Byte

There are no methods available that can forcibly clear all the bits of the status byte. The bits that are cleared for each operation are shown below.

#### When a query is made using the \*STB? command

None of the bits are cleared.

#### When serial polling is executed

Only the RQS bit is cleared.

#### When an \*CLS command is received

Receiving the \*CLS command will not clear the status byte itself, but the contents of the standard event register that affect the status byte. As a result, the corresponding bit of the status byte is cleared. Since the \*CLS command does not clear the output queue, bit 4 (MAV) of the status byte is unaffected. However, if the \*CLS command is received immediately after the program message terminator, the output queue is also cleared.

## 8.8.3 Standard Event Register

### Standard Event Register

7	6	5	4	3	2	1	0
PON	URQ	CME	EXE	DDE	QYE	RQC	OPC

#### Bit 7 PON (Power ON)

Set to "1" when the instrument is turned ON.

#### Bit 6 URQ (User Request)

Not used (always 0)

#### Bit 5 CME (Command Error)

Set to "1" when there is an error in the command syntax.

Example;

Misspelling of a command name, "9" exists in octal data.

#### Bit 4 EXE (Execution Error)

Set to "1" when the command syntax is correct, but the command cannot be executed in the current state of the instrument.

Example;

Parameter outside the range.

#### Bit 3 DDE (Device Dependent Error)

Set to "1" when a command cannot be executed for internal reasons other than a command syntax error and command execution error.

#### Bit 2 QYE (Query Error)

Set to "1" when a query command is transmitted, but the error queue is empty or the data are lost.

Example;

No response data, output queue overflowed and data were lost.

#### Bit 1 RQC (Request Control)

Not used (always 0)

#### Bit 0 OPC (Operation Complete)

Set to "1" when the operation specified by the \*OPC command (see section 8.7) has been completed.

### Bit Masking

If you wish to mask a certain bit of the standard event register so that it does not cause bit 5 (ESB) of the status byte to change, set the corresponding bit of the standard event enable register to "0."

For example, to mask bit 2 (QYE) so that the ESB bit is not set to "1" when a query error occurs, set bit 2 of the standard event enable register to "0." This is done using the \*ESE command. The \*ESE? request command can be used to query the standard event enable register to check whether each bit is set to "1" or "0." For details on the \*ESE command, see section 8.7.

### Standard Event Register Operation

Standard event register is a register for the eight types of events that occur inside the instrument. When any of the bits becomes a “1,” bit 5 (ESB) of the status byte is set to “1” (when the corresponding bit of the standard event enable register is also set to “1”).

Example

1. A query error occurs.
2. Bit 2 (QYE) is set to “1.”
3. If bit 2 of the standard event enable register is a “1”, then bit 5 (ESB) of the status byte is set to “1.”

In addition, you can also check what type of event occurred in the instrument by reading the contents of the standard event register.

### Reading the Standard Event Register

The \*ESR? command can be used to read the contents of the standard event register. The register is cleared after it is read.

### Clearing the Standard Event Register

The standard event register is cleared in the following three cases:

- When the contents of the standard event register are read using the \*ESR command.
- When a \*CLS command is received.
- When the instrument is powered up again.

## 8.8.4 Extended Event Register

The transition filter detects the changes in the condition register that indicate the internal condition of the instrument and writes the result to the extended event register.

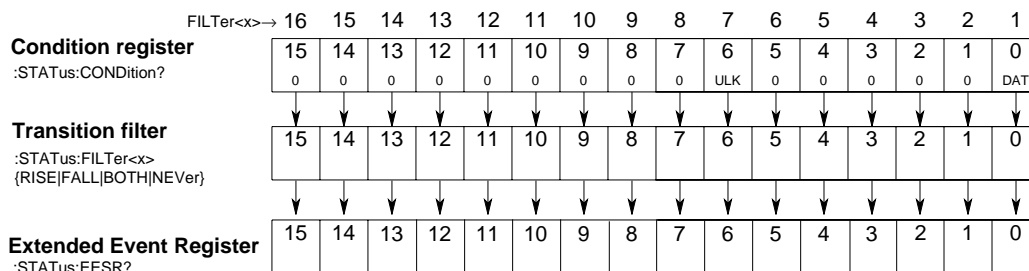

The meaning of each bit of the condition register is as follows:

Bit 0	DAT (Data Available) Set to “1” when the measured data and the computation result of statistical data are valid.
Bit 6	ULK (UnLock) Set to “1” when the PLL is unlocked.

The transition filter parameters detect changes in the specified bit (numeric suffix, 1 to 16) of the condition register in the following manner and overwrite the extended event register.

RISE	Sets the specified bit of the extended event register to “1”, on a 0-to-1 change.
FALL	Sets the specified bit of the extended event register to “1”, on a 1-to-0 change.
BOTH	Sets the specified bit of the extended event register to “1”, on both 0-to-1 and 1-to-0 change.
NEVer	Always 0.

### 8.8.5 Output Queue and Error Queue

#### Output Queue

The output queue stores response messages for the queries.

As shown in the example below, data are stored in order and read from the oldest ones first. The output queue is also cleared for the following cases:

- When a new message is received from the controller.
- When a deadlock occurs (see page 8-9)
- When a device clear command (DCL or SDC) is received.
- When the power is turned ON again.

The \*CLS command cannot be used to clear the output queue. Bit 4 (MAV) of the status byte can be used to check whether or not the output queue is empty.

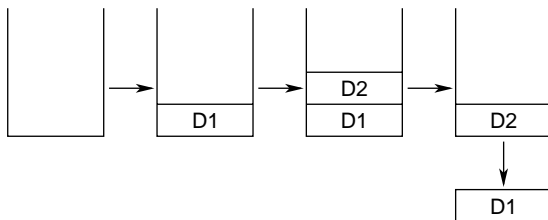

#### Error Queue

The error queue stores the error number and message when an error occurs. For example, if the controller sends an incorrect program message, the error number “113” and the message “Undefined header” are stored in the error queue when the error is displayed.

The STATUS:ERRor? query can be used to read the contents of the error queue. As with the output queue, the messages are read from the oldest ones first.

When the error queue overflows, the last message is replaced by the message “350, Queue overflow.”

The error queue is also cleared for the following cases:

- When a \*CLS command is received.
- When the power is turned ON again.

Bit 2 (EAV) of the status byte can be used to check whether or not the error queue is empty.

## 8.9 Sample Program

### 8.9.1 Before Programming

#### Environment

- Model: IBM-compatible PC
- Language: Visual Basic Ver5.0 Professional Edition or later.
- GPIB board: AT-GPIB/TNT IEEE-488.2 by National Instruments.

#### Settings on Visual Basic

Standard module used: Niglobal.bas and Vbib-32.bas

#### Settings on the TA120E

All sample programs given in this chapter use GP-IB address of "1" for the TA120E.

Set the GP-IB address to "1" according to the procedure in section 8.4.

### 8.9.2 Sample Program Image

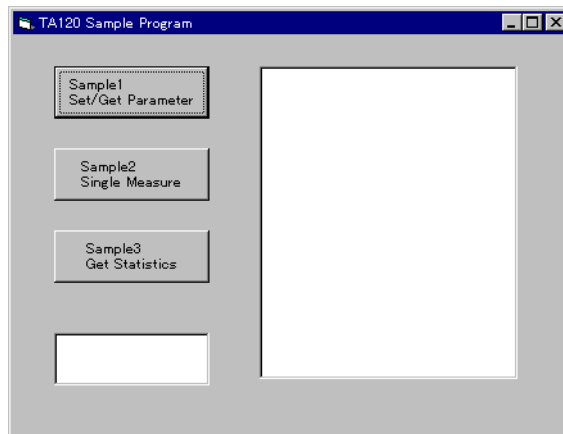



## 8.9.3 Initialization, Error, and Functions for Execution

```

----- Option Explicit
Dim StartFlag As Integer      'Start Flag Dim addr As Integer      'GPIO Address
Dim Timeout As Integer       'Timeout Dim Dev As Integer      'Device ID(GPIO)
Dim CtsFlag As Integer       'CTS Flag Dim term As String      'Terminator
Dim Query(12) As String      'Query String Dim Dummy As Integer

----- Private Function InitGpib() As Integer

Dim eos As Integer           'EOS
Dim eot As Integer           'EOI
Dim brd As Integer           'GPIO Board ID
Dim sts As Integer

eos = &HC0A                  'Terminator = LF
eot = 1                      'EOI = Enable
term = Chr(10)
Timeout = T10s              'Timeout = 10s

brd = ilfind("GPIO")
If (brd < 0) Then
    Call DisplayGPibError(brd, "ilfind")
    InitGpib = 1
    Exit Function
End If
Dev = ildev(0, addr, 0, Timeout, eot, eos)
If (Dev < 0) Then
    Call DisplayGPibError(Dev, "ildev")
    InitGpib = 1
    Exit Function
End If
sts = ilsic(brd)              'Set IFC
If (sts < 0) Then
    Call DisplayGPibError(sts, "ilsic")
    InitGpib = 1
    Exit Function
End If
InitGpib = 0
End Function

----- Private Sub DisplayGPibError(ByVal sts As Integer, ByVal msg As String)

Dim wrn As String
Dim ers As String
Dim ern As Integer

If (sts And TIMO) Then
    wrn = "Time out" + Chr(13)
Else
    wrn = ""
End If
If (sts And EERR) Then
    ern = iberr
    If (ern = EDVR) Then
        ers = "EDVR: System error"
    ElseIf (ern = ECIC) Then
        ers = "ECIC: Function requires GPIO board to be CIC"
    ElseIf (ern = ENOL) Then
        ers = "ENOL: No Listeners on the GPIO"
    ElseIf (ern = EADR) Then
        ers = "EADR: GPIO board not addressed correctly"
    ElseIf (ern = EARG) Then
        ers = "EARG: Invalid argument to function call"
    ElseIf (ern = ESAC) Then
        ers = "ESAC: GPIO board not System Controller as required"
    ElseIf (ern = EABO) Then
        ers = "EABO: I/O operation aborted(timeout)"
    ElseIf (ern = ENEB) Then
        ers = "ENEB: Nonexistent GPIO board"
    ElseIf (ern = EDMA) Then
        ers = "EDMA: DMA error"
    End If
End If

```

```

ElseIf (ern = EOIP) Then
    ers = "EOIP:I/O operation started before previous operation completed"
ElseIf (ern = ECAP) Then
    ers = "ECAP:No capability for intended operation"
ElseIf (ern = EFS0) Then
    ers = "EFS0:File system operation error"
ElseIf (ern = EBUS) Then
    ers = "EBUS:GPIB bus error"
ElseIf (ern = ESTB) Then
    ers = "ESTB:Serial poll status byte queue overflow"
ElseIf (ern = ESRQ) Then
    ers = "ESRQ:SRQ remains asserted"
ElseIf (ern = ETAB) Then
    ers = "ETAB:The return buffer is full"
ElseIf (ern = ELCK) Then
    ers = "ELCK:Address or board is locked"
Else
    ers = ""
End If
Else
    ers = ""
End If

MsgBox ("Status No. " + Str(sts) + Chr(13) + wrn + "Error No. " + Str(ern) + Chr(13) + ers +
Chr(13) + msg), vbExclamation, "Error!"
Call ibclr(Dev)
Call ibonl(Dev, 0)
Dev = -1
End Sub
----- Private Sub Command1_Click()

Dim sts As Integer

If (StartFlag = 1) Then
    Exit Sub
End If
StartFlag = 1
Text1.Text = "START"
List1.Clear
Dummy = DoEvents()
sts = SetParameter                                'Run Sample1 Set/Get Measure Parameter
If (sts = 0) Then
    List1.AddItem Query(0)
    List1.AddItem Query(1)
    List1.AddItem Query(2)
    List1.AddItem Query(3)
    List1.AddItem Query(4)
    List1.AddItem Query(5)
    List1.AddItem Query(6)
    List1.AddItem Query(7)
End If
Text1.Text = "END"
StartFlag = 0
End Sub
----- Private Sub Command2_Click()

Dim sts As Integer

If (StartFlag = 1) Then
    Exit Sub
End If
StartFlag = 1
Text1.Text = "START"
List1.Clear
Dummy = DoEvents()
sts = SingleMeasure                                'Run Sample2 Single Measure
Text1.Text = "END"
StartFlag = 0
End Sub

```

## 8.9 Sample Program

---

```
----- Private Sub Command3_Click()  
    Dim sts As Integer  
  
    If (StartFlag = 1) Then  
        Exit Sub  
    End If  
    StartFlag = 1  
    Text1.Text = "START"  
    List1.Clear  
    Dummy = DoEvents()  
    sts = GetStatistics           'Run Sample3 Get Statistics  
    If (sts = 0) Then  
        List1.AddItem Query(0)  
        List1.AddItem Query(1)  
        List1.AddItem Query(2)  
        List1.AddItem Query(3)  
        List1.AddItem Query(4)  
        List1.AddItem Query(5)  
        List1.AddItem Query(6)  
        List1.AddItem Query(7)  
        List1.AddItem Query(8)  
        List1.AddItem Query(9)  
        List1.AddItem Query(10)  
    End If  
    Text1.Text = "END"  
    StartFlag = 0  
End Sub  
  
----- Private Sub Form_Load()  
  
    StartFlag = 0           'Clear Start Flag  
    Dev = -1               'Clear device id  
    addr = 1               'GPIB Address = 1  
    Command1.Caption = "Sample1" + Chr(13) + "Set/Get Parameter"  
    Command2.Caption = "Sample2" + Chr(13) + "Single Measure"  
    Command3.Caption = "Sample3" + Chr(13) + "Get Statistics"  
    Text1.Text = ""  
  
End Sub  
-----
```

## 8.9.4 Setting Measurement Parameters or Querying the Setting

Sample1 Set/Get Parameter

```

----- Private Function SetParameter() As Integer
Dim msg As String           'Command buffer
Dim qry As String           'Query buffer
Dim sts As Integer

msg = Space$(100)
qry = Space$(100)

sts = InitGpib               'Initialize GPIB
If (sts <> 0) Then
    SetParameter = 1
    Exit Function
End If

msg = ":COMM:HEADER ON" + term           'Header = ON
sts = ilwrt(Dev, msg, Len(msg))          'Send Command
If (sts < 0) Then
    Call DisplayGPIBError(sts, msg)
    SetParameter = 1
    Exit Function
End If

msg = ":COMM:VERBOSE ON" + term          'Verbose = ON
sts = ilwrt(Dev, msg, Len(msg))          'Send Command
If (sts < 0) Then
    Call DisplayGPIBError(sts, msg)
    SetParameter = 1
    Exit Function
End If

msg = "STOP" + term                      'Measure Stop
sts = ilwrt(Dev, msg, Len(msg))          'Send Command
If (sts < 0) Then
    Call DisplayGPIBError(sts, msg)
    SetParameter = 1
    Exit Function
End If

msg = ":MEASURE:FUNCTION DTOC" + term     'Function = Data to Clock
sts = ilwrt(Dev, msg, Len(msg))          'Send Command
If (sts < 0) Then
    Call DisplayGPIBError(sts, msg)
    SetParameter = 1
    Exit Function
End If

msg = ":MEASURE:FUNCTION?" + term         'Get Function
sts = ilwrt(Dev, msg, Len(msg))          'Send Command
If (sts < 0) Then
    Call DisplayGPIBError(sts, msg)
    SetParameter = 1
    Exit Function
End If
sts = ilrd(Dev, qry, Len(qry))
If (sts < 0) Then
    Call DisplayGPIBError(sts, msg)
    SetParameter = 1
    Exit Function
End If
Query(0) = Left$(qry, ibcntl - 1)

```

## 8.9 Sample Program

---

```
msg = ":SAMPLE:GATE:MODE EVENT" + term      'Gate = Event(100000)
sts = ilwrt(Dev, msg, Len(msg))             'Send Command
If (sts < 0) Then
    Call DisplayGPIBError(sts, msg)
    SetParameter = 1
    Exit Function
End If
msg = ":SAMPle:GATE:MODE?" + term           'Get Gate Mode
sts = ilwrt(Dev, msg, Len(msg))             'Send Command
If (sts < 0) Then
    Call DisplayGPIBError(sts, msg)
    SetParameter = 1
    Exit Function
End If
sts = ilrd(Dev, qry, Len(qry))
If (sts < 0) Then
    Call DisplayGPIBError(sts, msg)
    SetParameter = 1
    Exit Function
End If
Query(1) = Left$(qry, ibcntl - 1)

msg = ":SAMPLE:ARMING:SOURCE AUTO" + term   'Arming = Auto
sts = ilwrt(Dev, msg, Len(msg))             'Send Command
If (sts < 0) Then
    Call DisplayGPIBError(sts, msg)
    SetParameter = 1
    Exit Function
End If
msg = ":SAMPLE:ARMING:SOURCE?" + term       'Get Arming
sts = ilwrt(Dev, msg, Len(msg))             'Send Command
If (sts < 0) Then
    Call DisplayGPIBError(sts, msg)
    SetParameter = 1
    Exit Function
End If
sts = ilrd(Dev, qry, Len(qry))
If (sts < 0) Then
    Call DisplayGPIBError(sts, msg)
    SetParameter = 1
    Exit Function
End If
Query(2) = Left$(qry, ibcntl - 1)

msg = ":SAMPLE:INHIBIT:STATE OFF" + term     'Inhibit = Off
sts = ilwrt(Dev, msg, Len(msg))             'Send Command
If (sts < 0) Then
    Call DisplayGPIBError(sts, msg)
    SetParameter = 1
    Exit Function
End If
msg = ":SAMPLE:INHIBIT:STATE?" + term       'Get Inhibit
sts = ilwrt(Dev, msg, Len(msg))             'Send Command
If (sts < 0) Then
    Call DisplayGPIBError(sts, msg)
    SetParameter = 1
    Exit Function
End If
sts = ilrd(Dev, qry, Len(qry))
If (sts < 0) Then
    Call DisplayGPIBError(sts, msg)
    SetParameter = 1
    Exit Function
End If
Query(3) = Left$(qry, ibcntl - 1)
```

```

msg = ":INPUT:DATA:POLARITY BOTH" + term      'Data Polarity = Both
sts = ilwrt(Dev, msg, Len(msg))              'Send Command
If (sts < 0) Then
    Call DisplayGPIBError(sts, msg)
    SetParameter = 1
    Exit Function
End If
msg = ":INPUT:DATA:POLARITY?" + term          'Get Data Polarity
sts = ilwrt(Dev, msg, Len(msg))              'Send Command
If (sts < 0) Then
    Call DisplayGPIBError(sts, msg)
    SetParameter = 1
    Exit Function
End If
sts = ilrd(Dev, qry, Len(qry))
If (sts < 0) Then
    Call DisplayGPIBError(sts, msg)
    SetParameter = 1
    Exit Function
End If
Query(4) = Left$(qry, ibcntl - 1)

msg = ":INPUT:DATA:TRIGGER:MODE AUTO" + term  'Trigger Mode = Auto
sts = ilwrt(Dev, msg, Len(msg))              'Send Command
If (sts < 0) Then
    Call DisplayGPIBError(sts, msg)
    SetParameter = 1
    Exit Function
End If
msg = ":INPUT:DATA:TRIGGER:MODE?" + term      'Get Trigger Mode
sts = ilwrt(Dev, msg, Len(msg))              'Send Command
If (sts < 0) Then
    Call DisplayGPIBError(sts, msg)
    SetParameter = 1
    Exit Function
End If
sts = ilrd(Dev, qry, Len(qry))
If (sts < 0) Then
    Call DisplayGPIBError(sts, msg)
    SetParameter = 1
    Exit Function
End If
Query(5) = Left$(qry, ibcntl - 1)

msg = ":INPUT:EQ:MODE ON" + term              'Equalizer = On
sts = ilwrt(Dev, msg, Len(msg))              'Send Command
If (sts < 0) Then
    Call DisplayGPIBError(sts, msg)
    SetParameter = 1
    Exit Function
End If
msg = ":INPUT:EQ:MODE?" + term                'Get Equalizer
sts = ilwrt(Dev, msg, Len(msg))              'Send Command
If (sts < 0) Then
    Call DisplayGPIBError(sts, msg)
    SetParameter = 1
    Exit Function
End If
sts = ilrd(Dev, qry, Len(qry))
If (sts < 0) Then
    Call DisplayGPIBError(sts, msg)
    SetParameter = 1
    Exit Function
End If
Query(6) = Left$(qry, ibcntl - 1)

```

## 8.9 Sample Program

---

```
msg = ":INPUT:PLL:MODE ON" + term           'PLL = On
sts = ilwrt(Dev, msg, Len(msg))           'Send Command
If (sts < 0) Then
    Call DisplayGPIBError(sts, msg)
    SetParameter = 1
    Exit Function
End If
msg = ":INPUT:PLL:MODE?" + term           'Get PLL
sts = ilwrt(Dev, msg, Len(msg))           'Send Command
If (sts < 0) Then
    Call DisplayGPIBError(sts, msg)
    SetParameter = 1
    Exit Function
End If
sts = ilrd(Dev, qry, Len(qry))
If (sts < 0) Then
    Call DisplayGPIBError(sts, msg)
    SetParameter = 1
    Exit Function
End If
Query(7) = Left$(qry, ibcntl - 1)

Call ibonl(Dev, 0)
SetParameter = 0
End Function
```

---

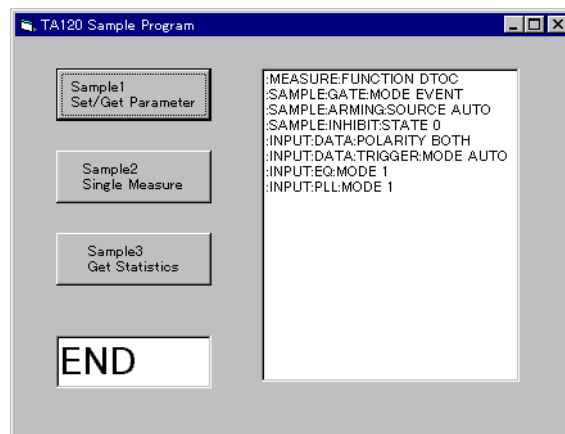

## 8.9.5 Executing Single Measurement

Sample2 Single Measure

```

----- Private Function SingleMeasure() As Integer
Dim msg As String           'Command buffer
Dim qry As String           'Query buffer
Dim sts As Integer

msg = Space$(100)
qry = Space$(100)

sts = InitGpib               'Initialize GPIB
If (sts <> 0) Then
    SingleMeasure = 1
    Exit Function
End If

msg = "STATUS:FILTER1 RISE" + term           'Filter1 Rise(Data Available)
sts = ilwrt(Dev, msg, Len(msg))             'Send Command
If (sts < 0) Then
    Call DisplayGPIBError(sts, msg)
    SingleMeasure = 1
    Exit Function
End If

msg = "STATUS:EESR?" + term                 'Clear Extended Event Register
sts = ilwrt(Dev, msg, Len(msg))             'Send Command
If (sts < 0) Then
    Call DisplayGPIBError(sts, msg)
    SingleMeasure = 1
    Exit Function
End If
sts = ilrd(Dev, qry, Len(qry))               'Read EESR
If (sts < 0) Then
    Call DisplayGPIBError(sts, msg)
    SingleMeasure = 1
    Exit Function
End If

msg = "SSTART" + term                       'Single Measure Start
sts = ilwrt(Dev, msg, Len(msg))             'Send Command
If (sts < 0) Then
    Call DisplayGPIBError(sts, msg)
    SingleMeasure = 1
    Exit Function
End If

Call ibonl(Dev, 0)
SingleMeasure = 0
End Function
-----

```

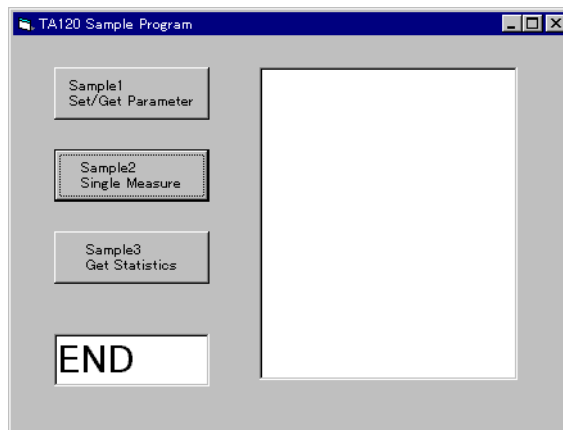



## 8.9.6 Querying the Measurement Statistics

```

Sample3 Get Statistics
----- Private Function GetStatistics() As Integer
Dim msg As String           'Command buffer
Dim qry As String           'Query buffer
Dim sts As Integer

msg = Space$(100)
qry = Space$(100)

sts = InitGpib               'Initialize GPIB
If (sts <> 0) Then
    GetStatistics = 1
    Exit Function
End If

msg = "COMMUNICATE:WAIT 1" + term           'Wait until data available
sts = ilwrt(Dev, msg, Len(msg))
If (sts < 0) Then
    Call DisplayGPIBError(sts, msg)
    GetStatistics = 1
    Exit Function
End If

msg = ":CALCULATION:AVERAGE?" + term       'Get Average value
sts = ilwrt(Dev, msg, Len(msg))
If (sts < 0) Then
    Call DisplayGPIBError(sts, msg)
    GetStatistics = 1
    Exit Function
End If
sts = ilrd(Dev, qry, Len(qry))
If (sts < 0) Then
    Call DisplayGPIBError(sts, msg)
    GetStatistics = 1
    Exit Function
End If
Query(0) = "Average:" + Left$(qry, ibcntl - 1)

msg = ":CALCULATION:SDEVIATION?" + term     'Get Standard Deviation value
sts = ilwrt(Dev, msg, Len(msg))
If (sts < 0) Then
    Call DisplayGPIBError(sts, msg)
    GetStatistics = 1
    Exit Function
End If
sts = ilrd(Dev, qry, Len(qry))
If (sts < 0) Then
    Call DisplayGPIBError(sts, msg)
    GetStatistics = 1
    Exit Function
End If
Query(1) = "Sigma:" + Left$(qry, ibcntl - 1)

```

```

msg = ":CALCULATION:MAXIMUM?" + term           'Get Maximum value
sts = ilwrt(Dev, msg, Len(msg))
If (sts < 0) Then
    Call DisplayGPIBError(sts, msg)
    GetStatistics = 1
    Exit Function
End If
sts = ilrd(Dev, qry, Len(qry))
If (sts < 0) Then
    Call DisplayGPIBError(sts, msg)
    GetStatistics = 1
    Exit Function
End If
Query(2) = "Maximum:" + Left$(qry, ibcntl - 1)

msg = ":CALCULATION:MINIMUM?" + term           'Get Minimum value
sts = ilwrt(Dev, msg, Len(msg))
If (sts < 0) Then
    Call DisplayGPIBError(sts, msg)
    GetStatistics = 1
    Exit Function
End If
sts = ilrd(Dev, qry, Len(qry))
If (sts < 0) Then
    Call DisplayGPIBError(sts, msg)
    GetStatistics = 1
    Exit Function
End If
Query(3) = "Minimum:" + Left$(qry, ibcntl - 1)

msg = ":CALCULATION:PTOPEAK?" + term           'Get Peak-Peak value
sts = ilwrt(Dev, msg, Len(msg))
If (sts < 0) Then
    Call DisplayGPIBError(sts, msg)
    GetStatistics = 1
    Exit Function
End If
sts = ilrd(Dev, qry, Len(qry))
If (sts < 0) Then
    Call DisplayGPIBError(sts, msg)
    GetStatistics = 1
    Exit Function
End If
Query(4) = "Peak-Peak:" + Left$(qry, ibcntl - 1)

msg = ":CALCULATION:FLUTTER?" + term           'Get Flutter value
sts = ilwrt(Dev, msg, Len(msg))
If (sts < 0) Then
    Call DisplayGPIBError(sts, msg)
    GetStatistics = 1
    Exit Function
End If
sts = ilrd(Dev, qry, Len(qry))
If (sts < 0) Then
    Call DisplayGPIBError(sts, msg)
    GetStatistics = 1
    Exit Function
End If
Query(5) = "Flutter:" + Left$(qry, ibcntl - 1)

```

## 8.9 Sample Program

---

```
msg = ":CALCULATION:JITTER?" + term           'Get Jitter value
sts = ilwrt(Dev, msg, Len(msg))
If (sts < 0) Then
    Call DisplayGPIBError(sts, msg)
    GetStatistics = 1
    Exit Function
End If
sts = ilrd(Dev, qry, Len(qry))
If (sts < 0) Then
    Call DisplayGPIBError(sts, msg)
    GetStatistics = 1
    Exit Function
End If
Query(6) = "Jitter:" + Left$(qry, ibcntl - 1)

msg = ":CALCULATION:ELERROR?" + term         'Get ELError value
sts = ilwrt(Dev, msg, Len(msg))
If (sts < 0) Then
    Call DisplayGPIBError(sts, msg)
    GetStatistics = 1
    Exit Function
End If
sts = ilrd(Dev, qry, Len(qry))
If (sts < 0) Then
    Call DisplayGPIBError(sts, msg)
    GetStatistics = 1
    Exit Function
End If
Query(7) = "ELError:" + Left$(qry, ibcntl - 1)

msg = ":CALCULATION:MELE?" + term           'Get MELE value
sts = ilwrt(Dev, msg, Len(msg))
If (sts < 0) Then
    Call DisplayGPIBError(sts, msg)
    GetStatistics = 1
    Exit Function
End If
sts = ilrd(Dev, qry, Len(qry))
If (sts < 0) Then
    Call DisplayGPIBError(sts, msg)
    GetStatistics = 1
    Exit Function
End If
Query(8) = "MELE:" + Left$(qry, ibcntl - 1)

msg = ":CALCULATION:TVALUE?" + term        'Get T value
sts = ilwrt(Dev, msg, Len(msg))
If (sts < 0) Then
    Call DisplayGPIBError(sts, msg)
    GetStatistics = 1
    Exit Function
End If
sts = ilrd(Dev, qry, Len(qry))
If (sts < 0) Then
    Call DisplayGPIBError(sts, msg)
    GetStatistics = 1
    Exit Function
End If
Query(9) = "T Value:" + Left$(qry, ibcntl - 1)
```

```

msg = ":CALCULATION:SNUMBER?" + term           'Get Sample Number value
sts = ilwrt(Dev, msg, Len(msg))
If (sts < 0) Then
    Call DisplayGPIBError(sts, msg)
    GetStatistics = 1
    Exit Function
End If
sts = ilrd(Dev, qry, Len(qry))
If (sts < 0) Then
    Call DisplayGPIBError(sts, msg)
    GetStatistics = 1
    Exit Function
End If
Query(10) = "Sample Num:" + Left$(qry, ibcntl - 1)

Call ibonl(Dev, 0)
GetStatistics = 0
End Function

```

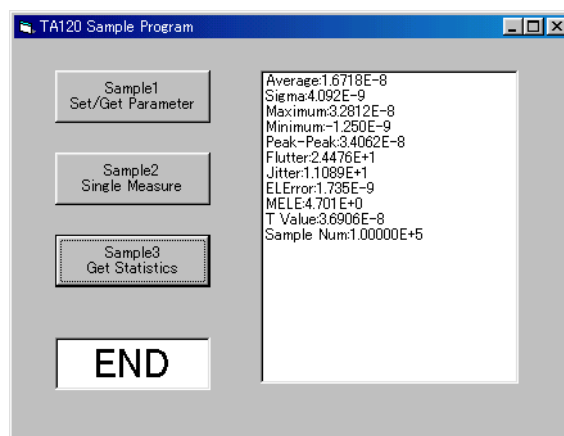

## 8.10 ASCII Character Code

The following table shows the ASCII character codes:

	0	1	2	3	4	5	6	7
0	<sup>0</sup> NUL	<sup>20</sup> DEL	<sup>40</sup> SP	<sup>60</sup> 0	<sup>100</sup> @	<sup>120</sup> P	<sup>140</sup> '	<sup>160</sup> p
1	<sup>1</sup> SOH	<sup>21</sup> DC1	<sup>41</sup> !	<sup>61</sup> 1	<sup>101</sup> A	<sup>121</sup> Q	<sup>141</sup> a	<sup>161</sup> q
2	<sup>2</sup> STX	<sup>22</sup> DC2	<sup>42</sup> "	<sup>62</sup> 2	<sup>102</sup> B	<sup>122</sup> R	<sup>142</sup> b	<sup>162</sup> r
3	<sup>3</sup> ETX	<sup>23</sup> DC3	<sup>43</sup> #	<sup>63</sup> 3	<sup>103</sup> C	<sup>123</sup> S	<sup>143</sup> c	<sup>163</sup> s
4	<sup>4</sup> EOT	<sup>24</sup> DC4	<sup>44</sup> \$	<sup>64</sup> 4	<sup>104</sup> D	<sup>124</sup> T	<sup>144</sup> d	<sup>164</sup> t
5	<sup>5</sup> ENQ	<sup>25</sup> NAK	<sup>45</sup> %	<sup>65</sup> 5	<sup>105</sup> E	<sup>125</sup> U	<sup>145</sup> e	<sup>165</sup> u
6	<sup>6</sup> ACK	<sup>26</sup> SYN	<sup>46</sup> &	<sup>66</sup> 6	<sup>106</sup> F	<sup>126</sup> V	<sup>146</sup> f	<sup>166</sup> v
7	<sup>7</sup> BEL	<sup>27</sup> ETB	<sup>47</sup> ,	<sup>67</sup> 7	<sup>107</sup> G	<sup>127</sup> W	<sup>147</sup> g	<sup>167</sup> w
8	<sup>10</sup> BS	<sup>30</sup> CAN	<sup>50</sup> (	<sup>70</sup> 8	<sup>110</sup> H	<sup>130</sup> X	<sup>150</sup> h	<sup>170</sup> x
9	<sup>11</sup> HT	<sup>31</sup> EM	<sup>51</sup> )	<sup>71</sup> 9	<sup>111</sup> I	<sup>131</sup> Y	<sup>151</sup> i	<sup>171</sup> y
A	<sup>12</sup> LF	<sup>32</sup> SUB	<sup>52</sup> *	<sup>72</sup> :	<sup>112</sup> J	<sup>132</sup> Z	<sup>152</sup> j	<sup>172</sup> z
B	<sup>13</sup> VT	<sup>33</sup> ESC	<sup>53</sup> +	<sup>73</sup> ;	<sup>113</sup> K	<sup>133</sup> [	<sup>153</sup> k	<sup>173</sup> {
C	<sup>14</sup> FF	<sup>34</sup> FS	<sup>54</sup> ,	<sup>74</sup> <	<sup>114</sup> L	<sup>134</sup> \	<sup>154</sup> l	<sup>174</sup> 
D	<sup>15</sup> CR	<sup>35</sup> GS	<sup>55</sup> -	<sup>75</sup> =	<sup>115</sup> M	<sup>135</sup> ]	<sup>155</sup> m	<sup>175</sup> }
E	<sup>16</sup> SO	<sup>36</sup> RS	<sup>56</sup> .	<sup>76</sup> >	<sup>116</sup> N	<sup>136</sup> ^	<sup>156</sup> n	<sup>176</sup> ~
F	<sup>17</sup> SI	<sup>37</sup> US	<sup>57</sup> /	<sup>77</sup> ?	<sup>117</sup> O	<sup>137</sup> _	<sup>157</sup> o	<sup>177</sup> DEL (RUBOUT)
	Address command	Universal command	Listener address		Talker address		Secondary command	

### Example

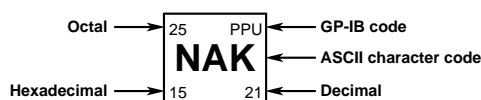

## 9.1 Troubleshooting

- For the appropriate corrective actions when an error code is shown on the display, see section 9.2.
- If servicing is necessary, or if the instrument is not operating correctly after performing the following corrective actions, contact your nearest YOKOGAWA dealer as listed on the back cover of this manual.

Problem	Probable Cause	Corrective Action	Section
The power does not turn ON.	Using a power supply outside the ratings.	Use a correct power supply.	3.3
	The circuit breaker is OFF.	Find the reason that caused the circuit breaker to turn OFF. If there is no problem, turn it ON.	9.8
The display is not correct.	The system has malfunctioned.	Reboot the system.	3.4
	Noise appears on the display.	Install the TA120E where there is no noise. Remove the noise.	3.2 —
	The ambient temperature or humidity is outside the specifications.	Install the TA120E in a place that meets the specifications.	3.2
Keys do not work.	Key lock is ON.	Turn OFF the key lock.	7.6
	The TA120E is in the remote mode.	Set the TA120E in the local mode.	7.2
Cannot make measurements.	The trigger mode or slice level is not correct.	Set them correctly.	4.3
	The RF signal or clock signal is not input correctly.	Input the RF signal or clock signal correctly.	3.5, 3.6, 4.2, 4.7, 4.8
	The measurement range is exceeded.	Check the measurement range.	4.1
	Arming is not adequate.	Check arming.	4.5
	Inhibit is not adequate.	Check inhibit.	4.6

## 9.2 Error Code Description and Corrective Actions

There are cases in which error messages appear on the display during operation or error codes and error messages appear on the PC (controller) when using the communication function. This section will describe the meanings of the messages and the corrective actions. If the corrective action indicates servicing, please contact your nearest YOKOGAWA dealer as listed on the back cover of this manual.

### Error Codes and Error Messages

Error codes are shown on the display. If you query the error using the "STATUS:ERROR?" command from the PC through the communication function, the error code and error message are displayed on the monitor of your PC.

#### Error in communication command

Code	Message	Description and Corrective Action	Section
102	Syntax error	There is a syntax error other than the ones listed below.	8.6, 8.7
103	Invalid separator	<DATA SEPARATOR> is missing. Use a comma to separate the data.	8.6
104	Data type error	The <DATA> type is not correct. Rewrite using the correct data form.	8.6
108	Parameter not allowed	There are too many <DATA>. Check the number of data points.	8.6, 8.7
109	Missing parameter	Required <DATA> is missing. Write the required data.	8.6, 8.7
111	Header separator error	<HEADER SEPARATOR> is missing. Use a space to separate the header and data.	8.6
112	Program mnemonic too long	<mnemonic> may be too long. Check the mnemonic (alphanumerical character string).	8.7
113	Undefined header	No such command. Check the header.	8.7
114	Header suffix out of range	The value of <HEADER> is not correct. Check the header.	8.7
120	Numeric data error	The mantissa of the value is missing. A mantissa is required before the exponent in the <NRf> form.	8.6
123	Exponent too large	The exponent is too large. Make the exponent after "E" smaller in the <NR3> form.	8.6, 8.7
124	Too many digits	There are too many significant digits. The value must be less than or equal to 255 digits.	8.6, 8.7
128	Numeric data not allowed	Numeric data cannot be used. Write in a data form other than the <NRf> form.	8.6, 8.7
131	Invalid suffix	The unit is not correct. Check the unit of the <Voltage> and <Time>.	8.6
134	Suffix too long	The spelling of the unit is too long. Check the unit of the <Voltage> and <Time>.	8.6
138	Suffix not allowed	Units cannot be used. Units other than those for <Voltage> and <Time> cannot be used.	8.6
141	Invalid character data	No such selection available. Select character data from the selections available in {... ... ...}.	8.7
144	Character data too long	The spelling of <CHARACTER DATA> is too long. Check the spelling of the character strings in {... ... ...}.	8.7

## 9.2 Error Code Description and Corrective Actions

Code	Message	Description and Corrective Action	Section
148	Character data not allowed	<CHARACTER DATA> cannot be used. Write in a data form other than {...!...!...}.	8.7
150	String data error	There is no delimiter to the right of <STRING DATA>. Enclose <String data> in double quotation or single quotation marks.	8.6
151	Invalid string data	The contents of <STRING DATA> are inappropriate. <String data> is too long or invalid character is present.	8.7
158	String data not allowed	<STRING DATA> cannot be used. Write in a data form other than <String data> form.	8.7
161	Invalid block data	The data length of <BLOCK DATA> does not match. <Block data> cannot be used.	8.6, 8.7
168	Block data not allowed	<BLOCK DATA> cannot be used. <Block data> cannot be used.	8.6, 8.7
171	Invalid expression	There is an invalid character in the <EXPRESSION DATA>. Equations cannot be used.	8.7
178	Expression data not allowed	<EXPRESSION DATA> cannot be used. Equations cannot be used.	8.7
181	Invalid outside macro definition	The placeholder is outside the macro. Macro functions defined in IEEE488.2 are not supported.	-

### Error in communication execution

Code	Message	Description and Corrective Action	Section
221	Setting conflict	There is a conflict in the setup information. Check the relevant setting values.	8.7
222	Data out of range	The value of <DATA> is outside the range. Check the range.	8.7
223	Too much data	The length of <DATA> is too long. Check the length of the data.	8.7
224	Illegal parameter value	The value of <DATA> is inappropriate. Check the range.	8.7
241	Hardware missing	The hardware is not implemented. Check the existence of options.	-
260	Expression error	<EXPRESSION DATA> is not correct. Equations cannot be used.	-
270	Macro error	Macro nesting is too deep. Macro functions defined in IEEE488.2 are not supported.	-
272	Macro execution error	Macros cannot be used. Macro functions defined in IEEE488.2 are not supported.	-
273	Illegal macro label	The macro label is inappropriate. Macro functions defined in IEEE488.2 are not supported.	-
275	Macro definition too long	The macro is too long. Macro functions defined in IEEE488.2 are not supported.	-
276	Macro recursion error	Macro was recursively called. Macro functions defined in IEEE488.2 are not supported.	-
277	Macro redefinition not allowed	Macros cannot be redefined. Macro functions defined in IEEE488.2 are not supported.	-
278	Macro header not found	The macro is not defined. Macro functions defined in IEEE488.2 are not supported.	-
708	Cannot output data while measuring.	Cannot transmit data while measurement is in progress. Stop the measurement using the STOP or SSTART command.	8.7.11, 8.7.14



## 9.2 Error Code Description and Corrective Actions

---

### Error in communication query

Code	Message	Description and Corrective Action	Section
410	Query INTERRUPTED	Query transmission was aborted. Check the order of transmission and reception.	8.6
420	Query UNTERMINATED	There is no response that can be transmitted. Check the order of transmission and reception.	8.6
430	Query DEADLOCKED	Deadlock occurred. Aborting transmission. Set the length of a program message including the <PMT> to less than or equal to 1024 bytes.	8.6
440	Query UNTERMINATED after indefinite response	The order to request the response is not correct. Do not specify a query after the *IDN? or *OPT? command.	-

---

### Error in system operation

Code	Message	Description and Corrective Action	Section
906	Fan stopped. Turn OFF the power immediately.	The cooling fan has stopped. Immediately turn OFF the power.	3.4
909	No Battery.	The backup battery is dead. Servicing is required for battery replacement.	3.4
910	Calibration data lost.	The calibration value is abnormal. Servicing is required for calibration.	-
912	Fatal error in Communication -driver	Communication driver error. Servicing required.	-
914	Time out occurs in Communication	Communication timeout error. Make sure to receive the data within the timeout time. There may a problem in the communication line.	-

---

### Miscellaneous

Code	Message	Description and Corrective Action	Section
350	Queue overflow	Read the error queue. Occurs when there are 16 or more messages in the error buffer.	8.8

---

### Note

Code "350" occurs when the error queue overflows. This error is output only during a STATUS:ERROR? query and does not appear on the screen.

---

## 9.3 Adjusting the Zero Position of the Needle

### Keys

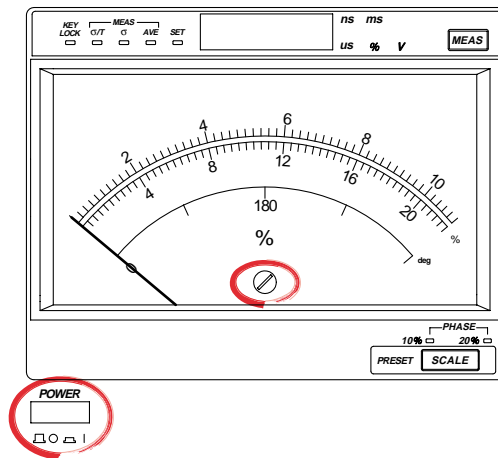

### Procedure

1. Check that the power switch is turned OFF.
2. Adjust the needle by turning the adjustment trimmer  with a flat-head screwdriver so that the needle is exactly over the zero line.

### Explanation

When the zero position of the needle goes off alignment, you can adjust the needle position using the adjustment trimmer  located at the center of the meter. View the analog meter straight on (eye level horizontal to the zero line), and adjust so that the needle is exactly over the zero line.

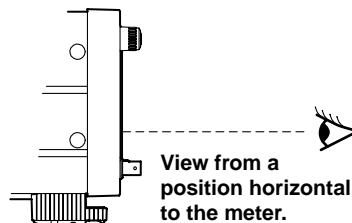

## 9.4 Performing a Self-Test

### Keys

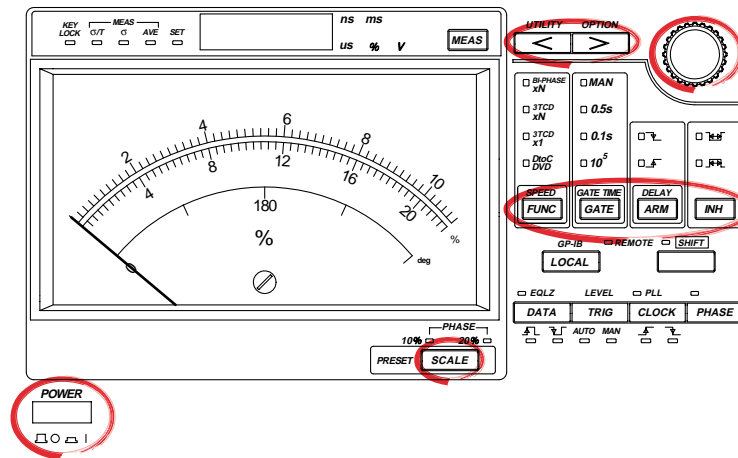

### Procedure

#### Removing the signal cable

1. Remove all cables that are connected to the TA120E (input and output cables) excluding the power cable and GP-IB cable. Make sure that the TA120E is not in the remote mode at this point.  
For the procedure in switching from remote mode to local mode, see section 8.2.

#### Setting the TA in the maintenance mode

2. Check that the power switch is turned OFF.
3. While pressing the SCALE key, turn ON the power switch. Hold the SCALE key down for approximately 3 seconds. After displaying [TA120E→704420→V-x.xx(version display)→tESt→PASS], the characters [tEST] appear on the display. The TA120E enters the start condition in the maintenance mode.

#### Testing the keys and rotary knob

- **Performing the test**
  4. Press the FUNC key. The characters [KEY] appear on the display.
  5. Press a key. Confirm that the character corresponding to the pressed key is shown on the display. In addition, confirm that a character indicating the rotation direction is shown on the display when the rotary knob is turned.
- **Returning to the start condition in the maintenance mode.**
  6. Press the < key twice. The characters [tEST] appear on the display and the TA120E enters the start condition in the maintenance mode.

**Testing the indicator**

4. Press the GATE key. The characters [LEd] appear on the display.
  5. Turn the rotary knob to the right. Confirm that the lit position of the indicator moves from the upper left to the lower right in order. The 7-segment LED and decimal point are also lit one segment at a time. Turn the rotary to the left and confirm that the lit position of the indicator moves from the lower right to the upper left in order.
- **Returning to the start condition in the maintenance mode.**
6. Press the < key once. The characters [tEST] appear on the display and the TA120E returns to the start condition in the maintenance mode.

**Testing the meter**

4. Press the ARM key. The characters [MEtEr] appear on the display. Confirm that the needle points slightly to the right of the center of the scale.
  5. Turn the rotary knob to the right. Confirm that the meter needle moves to the right and goes off the scales beyond the maximum scale line. Turn the rotary knob to the left and confirm that the needle moves to the left and points to the zero position.
- **Returning to the start condition in the maintenance mode.**
6. Press the < key once. The characters [tEST] appear on the display and the TA120E returns to the start condition in the maintenance mode.

**Testing the board**

4. Press the INH key. After the test items [CPu→MEAS] are shown on the display, [PASS] or [FAiL] is displayed.  
If [PASS] is displayed, the board is operating normally. Proceed to step 9.  
If [FAiL] is displayed, a problem has been detected. Proceed to step 5.
- **Checking the CPU board**
5. Turn the rotary knob to select [CPu].
  6. Press the > key. [PASS] or a hexadecimal value is displayed.  
If [PASS] is displayed, the CPU board is operating normally.  
If a hexadecimal value is displayed, a problem has been detected. Please note the hexadecimal value that is displayed.
- **Checking the measurement board**
7. Turn the rotary knob to select [MEAS].
  8. Press the > key. [PASS] or a hexadecimal value is displayed.  
If [PASS] is displayed, the measurement board is operating normally.  
If a hexadecimal value is displayed, a problem has been detected. Please note the hexadecimal value that is displayed.
- **Returning to the start condition in the maintenance mode.**
9. Press the < key once. The characters [tEST] appear on the display and the TA120E returns to the start condition in the maintenance mode.

**Note**

When you wish to perform measurement again after the self-test, reboot the TA120E.

### Explanation

If a problem is detected during the self-test, please contact your nearest YOKOGAWA dealer as listed on the back cover of this manual for repairs.

#### Signal cable

When performing self-test, remove all cables that are connected to the TA120E (input and output cables) excluding the power cable and GP-IB cable. If the TA120E is in the remote mode at this point, self-test cannot be performed. Switch from remote mode to local mode.

#### Key and rotary knob test

When you press a key or turn the rotary knob, the corresponding digital characters are displayed. If the digital characters indicated in the table below are displayed, the key or rotary knob is operating normally. The table indicating the correspondence between the alphanumeric characters and digital characters are provided on page viii.

Key/Rotary Knob	Digital Characters
FUNC	FunC
GATE	GAte
ARM	ArM
INH	inH
LOCAL	LoCAL
SHIFT	SHiFt
DATA	dAtA
TRIG	triG
CLOCK	CLoCK
PHASE	PHASE
>	riGHt
<	LEFt
MEAS	MEAS
SCALE	SCALE
Rotary knob to the right	rot r
Rotary knob to the left	rot L

#### Indicator test

You can test all the indicators including the 7-segment LED and the decimal point on the display. However, the indicators for the RF input connector cannot be tested. Turn the rotary knob and confirm that the lit position of the indicator moves accordingly. If all the indicators except the RF input connector indicator light up in order, the indicators are operating normally.

#### Meter test

You can test the analog meter through the range of motion of the needle. If the needle moves from the zero position of the scale to beyond the maximum scale line when performing the test in this section, it is operating normally.

#### Board test

You can test the CPU board and the measurement board. If [PASS] is displayed, the board is operating normally. If a problem is detected, a hexadecimal value indicating the problem can be displayed separately for the CPU board and measurement board. Please quote this number when contacting your nearest YOKOGAWA dealer for repairs.

## 9.5 Performing Calibration (Changing the Factory Default Calibration Value)

### Keys

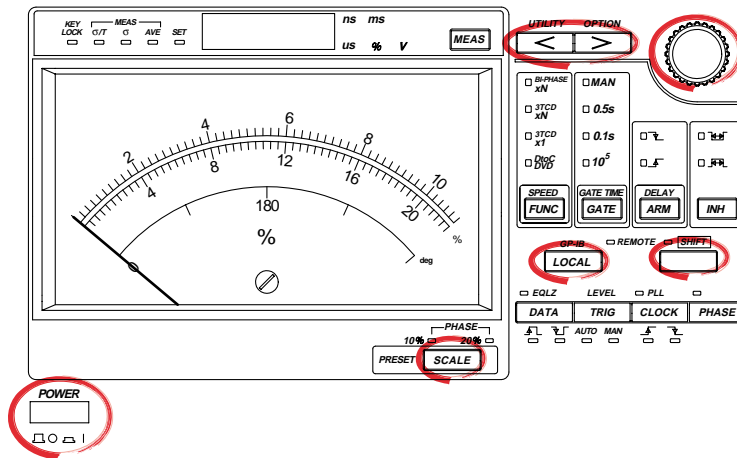

### Procedure

#### Note

When calibration completes normally, a new calibration value is obtained. To apply the calibration value obtained through this operation, you must change the factory default calibration value. If you change the factory default calibration value, you cannot set it back. Please confirm that it is okay to change the factory default calibration value beforehand. Note that initialization (see section 7.4) will not set the calibration value back to factory default.

#### Carry out the operations below in the following cases:

- When the allowable range is exceeded in the performance test described in section 9.6.
- When parts of the TA120E have been replaced.

#### Removing the signal cable

1. Remove all cables that are connected to the TA120E (input and output cables) excluding the power cable and GP-IB cable. Make sure that the TA120E is not in the remote mode at this point.  
For the procedure in switching from remote mode to local mode, see section 8.2.

#### Setting the TA120E in the maintenance mode

2. Check that the power switch is turned OFF.
3. While pressing the SCALE key, turn ON the power switch. Hold the SCALE key down for approximately 3 seconds. After displaying [TA120E→704420→V-x.xx(version display)→tEST→PASS, the characters [tEST] appear on the display. The TA120E enters the start condition in the maintenance mode. Let the TA120E warm up for at least 30 minutes in this condition.

## 9.5 Performing Calibration (Changing the Factory Default Calibration Value)

---

### Performing calibration

4. Press the LOCAL key. After the calibration items [dC→tV→PHASE→FunC] are shown on the display, [PASS] or [FAiL] is displayed. This takes three to four minutes.

If [PASS] is displayed, the calibration has been performed normally, and the new calibration value has been obtained. To apply the new calibration value (change the factory default calibration value), proceed to step 5. Otherwise, proceed to step 14.

If [FAiL] is displayed, a problem has occurred. Proceed to step 6.

- **Changing the factory default calibration value**

5. Press the SHIFT key. The characters [CoPY] appear on the display and the factory default calibration value is changed. The new calibration value will take effect the next time the power is turned ON. Proceed to step 14.

If the calibration fails to complete normally, [CoPY] is displayed and then [FAiL] is displayed. In this case, servicing is required. Please contact your nearest YOKOGAWA dealer as listed on the back cover of this manual for repairs.

### Checking each of the calibration results

- **Checking the DC voltage level**

6. Turn the rotary knob to select [dC].
7. Press the > key. [PASS] or a hexadecimal value is displayed.

If [PASS] is displayed, the DC voltage level is normal.

If a hexadecimal value is displayed, a problem has occurred. Please note the hexadecimal value that is displayed.

- **Checking the time-voltage converter**

8. Turn the rotary knob to select [tV].
9. Press the > key. [PASS] or a hexadecimal value is displayed.

If [PASS] is displayed, the time-voltage converter is operating normally.

If a hexadecimal value is displayed, a problem has occurred. Please note the hexadecimal value that is displayed.

- **Checking the programmable delay circuit**

10. Turn the rotary knob to select [PHASE].
11. Press the > key. [PASS] or a hexadecimal value is displayed.

If [PASS] is displayed, the programmable delay circuit is operating normally.

If a hexadecimal value is displayed, a problem has occurred. Please note the hexadecimal value that is displayed.

- **Checking the signal multiplexer, the fractional pulse generator, and their peripheral circuits**

12. Turn the rotary knob to select [FunC].
13. Press the > key. [PASS] or a hexadecimal value is displayed.

If [PASS] is displayed, the signal multiplexer, fractional pulse generator, and their peripheral circuits are operating normally.

If a hexadecimal value is displayed, a problem has occurred. Please note the hexadecimal value that is displayed.

### Returning to the start condition in the maintenance mode.

14. Press the < key once. The characters [tEST] appear on the display and the TA120E enters the start condition in the maintenance mode.

### Rebooting the system.

15. Turn OFF the power switch.
16. After approximately 3 seconds, turn ON the power switch. Check that [TA120E→704420→tEst→PASS] is shown on the display. The TA120E is now ready to make measurements.

### Explanation

The calibration function can be used to change the factory default calibration value of the TA120E. However, once you make the change, you cannot set the calibration value back to factory default. Perform calibration when the allowable range is exceeded in the performance test described in section 9.6 or when parts of the TA120E are replaced. If a problem is detected during the calibration operation, please contact your nearest YOKOGAWA dealer as listed on the back cover of this manual for repairs.

### Signal cable

When performing calibration, remove all cables that are connected to the TA120E (input and output cables) excluding the power cable and GP-IB cable.

If the TA120E is in the remote mode at this point, calibration cannot be performed. Switch from remote mode to local mode.

### Warm Up

Warm up the TA120E for at least 30 minutes with the power turned ON before performing calibration.

### Calibrated items

The following items can be calibrated:

- DC voltage level.
- Time-voltage converter.
- Programmable delay circuit.
- The Signal multiplexer, the fractional pulse generator, and their peripheral circuits.

### Changing the factory default calibration value

- When calibration completes normally, a new calibration value is obtained. To apply the new calibration value, you must change the factory default calibration value. If you change the factory default calibration value, you cannot set it back. Please confirm that it is okay to change the factory default calibration value beforehand. Note that initialization (see section 7.4) will not set the calibration value back to factory default.
- If the factory default calibration value is not changed, the new calibration value is not applied.
- The factory default calibration value can be changed only when all calibrations complete normally.
- If you are not going to change the factory default calibration value, return to the start condition in the maintenance mode or turn OFF the power switch.



## 9.5 Performing Calibration (Changing the Factory Default Calibration Value)

---

### Checking the calibration result

If [PASS] is displayed after calibration, the operation is normal. If a problem is detected, a hexadecimal value indicating the problem can be displayed separately for each circuit. Please quote this number when contacting your nearest YOKOGAWA dealer for repairs.

### Rebooting the system

After calibration, check that the TA120E starts up normally and that it is ready to make measurements.

### Calibration using the GP-IB command

You can perform calibration using a GP-IB command. In this case, connect the GP-IB cable.

- **When you wish to set the calibration value back to the factory default when the system is rebooted**
  - Perform calibration using the \*CAL? command (see page 8-33). You can make measurements using the calibration value obtained through the execution of the \*CAL? command until the system is rebooted. Once you turn OFF the TA120E and turn it back ON, the calibration value returns to the factory default.
  - You cannot perform the calibration corresponding to the \*CAL? command from the front panel of the TA120E.
- **When you wish to change the factory default calibration value**
  - Perform the calibration using the XCAL command. After calibration, the factory default calibration value is changed. Because the factory default calibration value is overwritten, you cannot set the calibration value back to factory default even if you execute the \*CAL? command.
  - Calibration using the XCAL command is the same function as the calibration performed from the front panel.

Command	Description
*CAL?	Execute calibration. The factory default calibration value is not changed.
DUMPENABLE	Enable the calibration value to be changed.
XCAL	Execute calibration and then change the factory default calibration value.
DUMPDISABLE	Prohibits the calibration value from being changed.

### Note

After you enable the calibration value to be changed using the DUMPENABLE command, execute calibration and change the factory default calibration value using the XCAL command, prevent the calibration value from being changed inadvertently using the DUMPDISABLE command.

---

## 9.6 Executing the Performance Test



### CAUTION

- Do not apply a voltage exceeding the maximum input voltage to the input terminal of each instrument. This may cause damage to the input section.
- Do not short the output terminals of instruments or apply external voltage to it. This may cause damage to the internal circuitry.

### Trigger Voltage (Slice Level) Accuracy Test

#### Items Required

The following items are required:

#### DC voltage generator

- Voltage accuracy: 1 mV or less
- Recommended instrument: Programmable DC voltage/current source 7651 (YOKOGAWA)

The procedure for testing the trigger voltage accuracy using the recommended instruments is described below.

#### Connecting the Instrument

- Check that the power switch is turned OFF on all instruments before connecting them.
- Connect the output of the DC voltage generator to the RF input connector of the TA120E.

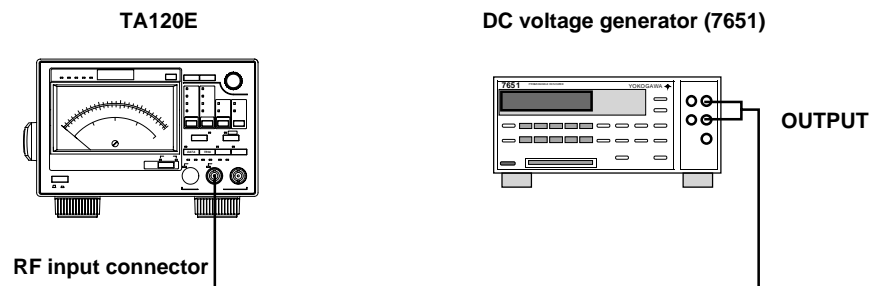

#### Instrument settings

- TA120E  
Measurement function: 3TCD  
Trigger mode: MAN
- 7651  
Output level: 4.000 V, 0 V, and -4.000 V

#### Note

If noise is present due to the influence from the outside environment, connect a 1- $\mu$ F capacitor between the signal line and ground.

## 9.6 Executing the Performance Test

---

### Test method

- Test the TA120E after 30 minutes of warm-up.
- This test compares the applied DC voltage to the trigger level (slice level) set by the TA120E and checks the error in the trigger level.
- The actual detection of the trigger level is done by monitoring the RF signal input indicator of the TA120E.

### Test procedure

1. Set the output level of the 7651 to 4.000 V.
2. Set the trigger level of the TA120E to 4.100 V.
3. Decrease the trigger level of the TA120E in 1-mV steps. Gradually decrease the trigger level and record the voltage at which the RF signal input indicator blinks as VL.
4. Set the trigger level of the TA120E to 3.900 V.
5. Increase the trigger level of the TA120E in 1-mV steps. Gradually increase the trigger level and record the voltage at which the RF signal input indicator blinks as VH.
6. The trigger voltage is derived by taking the average of VL and VH. Confirm that this voltage is within the allowable range.  
 $VTRIG = (VL + VH)/2$
7. Perform similar tests by setting the output of the DC voltage generator to 0 V and -4.000 V.

### Test result

Voltage of the 7651	VL	VH	VTRIG	Allowable Range
4.000V				3.83 V to 4.17 V
0.000V				-0.01 V to 0.01 V
-4.000V				-4.17 V to -3.83 V

## Input Sensitivity Test

### Items Required

The following items are required:

- **Synthesized signal generator**
  - Frequency range: 720 kHz to 10 MHz
  - Output level: 720 mVrms or more
  - Output level accuracy: 0.15 dB or less
  - Recommended instrument: Synthesized signal generator 8657B (Agilent Technologies)
- **50-Ω terminator**  
Recommended device: 700976 (YOKOGAWA)

The procedure for testing the input sensitivity using the recommended instruments is described below.

### Connecting the Instrument

- Check that the power switch is turned OFF on all instruments before connecting them.
- Connect the output of the synthesized signal generator to the RF input connector of the TA120E through the 50-Ω terminator.

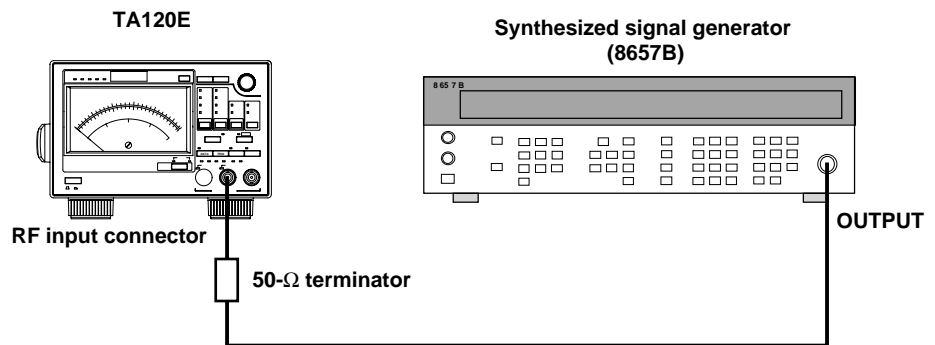

### Instrument settings

- TA120E
  - Measurement function: 3TCD(×N)
  - Polarity of the data signal: 
  - Speed (N): 1.0, 4.0, 6.2, and 10.0
  - Gate: 0.1 s
  - Trigger mode: MAN
  - Slice level: 0.000 V
- 8657B
  - Output level: 35 mVrms
  - Output frequency: 720 kHz, 2.88 MHz, 4.5 MHz, and 7.2 MHz

## 9.6 Executing the Performance Test

---

### Test method

- Test the TA120E after 30 minutes of warm-up.
- Set the frequency of the 8657B to the values indicated in the table below and confirm that the standard deviation  $\sigma$  (jitter) and the average value under the 3T jitter measurement of the TA120E are within the allowable range in the table.

### Test procedure

1. Set the output level of the 8657B to 35 mVrms and the frequency to 720 kHz.
2. Set the speed of the TA120E to [1.0].
3. Read the standard deviation  $\sigma$  and the average value. Confirm that the values are within the allowable range.
4. Set the output level and frequency of the 8657B and the speed of the TA120E according to the table below, then perform the test in a similar fashion.

### Test result

Frequency of the 8657B	Speed of the TA120E	Standard Deviation $\sigma$ (Jitter)	Average Value
		Measured Value Allowable Range	Measured Value Allowavle Range
720 kHz	1.0	3.8 ns or less	600 ns to 786 ns
2.88 MHz	4.0	1.2 ns or less	149 ns to 198 ns
4.5 MHz	6.2	0.9 ns or less	95ns to 127 ns
7.2 MHz	10.0	0.6 ns or less	58.9 ns to 79.9 ns

### 3T Jitter Measurement Test

#### Items Required

The following items are required:

- **Synthesized signal generator**
  - Frequency range: 720 kHz to 10 MHz
  - Output level: 720 mVrms or more
  - Recommended instrument: Synthesized signal generator 8657B (Agilent Technologies)
- **50-Ω terminator**  
Recommended device: 700976 (YOKOGAWA)



The procedure for testing the 3T jitter measurement using the recommended instruments is described below.

#### Connecting the Instrument

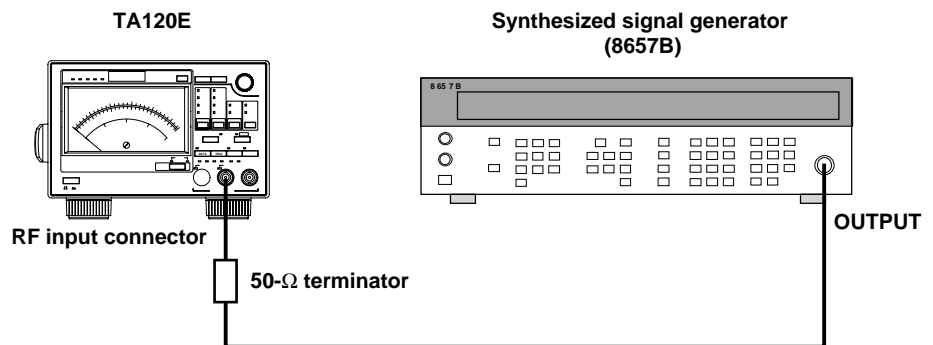
- Check that the power switch is turned OFF on all instruments before connecting them.
- Connect the output of the synthesized signal generator to the RF input connector of the TA120E through the 50-Ω terminator.



#### Instrument settings

- TA120E
  - Measurement function: 3TCD( $\times N$ )
  - Polarity of the data signal: , 
  - Speed (N): 1.0, 4.0, 6.2, and 10.0
  - Gate: 0.1 s
  - Trigger mode: MAN
  - Slice level: 0.000 V
- 8657B
  - Output level: 360 mVrms
  - Output frequency: 720 kHz, 2.88 MHz, 4.5 MHz, and 7.2 MHz

## 9.6 Executing the Performance Test

### Test method

- Test the TA120E after 30 minutes of warm-up.
- Set the frequency of the 8657B to the values indicated in the table below and confirm that the standard deviation  $\sigma$  (jitter) and the average value under the 3T jitter measurement of the TA120E are within the determination reference in the table.

### Test procedure

1. Set the output level of the 8657B to 360 mVrms and the frequency to 720 kHz.
2. Set the speed of the TA120E to [1.0] and the polarity of the data signal to  $\uparrow\downarrow$ .
3. Read the standard deviation  $\sigma$  and the average value. Confirm that the values are within the allowable range.
4. Set the output level and frequency of the 8657B and the speed and polarity of the data signal of the TA120E according to the table below, then perform the test in a similar fashion.

### Test result

- **Polarity of the Data Signal:**  $\uparrow\downarrow$

Frequency of the 8657B	Speed of the TA120E	Standard Deviation $\sigma$ (Jitter)		Average Value	
		Measured Value	Allowable Range	Measured Value	Allowable Range
720 kHz	1.0	0.65 ns or less		684 ns to 705 ns	
2.88 MHz	4.0	0.39 ns or less		170 ns to 177 ns	
4.5 MHz	6.2	0.36 ns or less		109 ns to 114 ns	
7.2 MHz	10.0	0.34 ns or less		67.2 ns to 71.6 ns	

- **Polarity of the data signal:**  $\downarrow\uparrow$

Frequency of the 8657B	Speed of the TA120E	Standard Deviation $\sigma$ (Jitter)		Average Value	
		Measured Value	Allowable Range	Measured Value	Allowable Range
720 kHz	1.0	0.65 ns or less		684 ns to 705 ns	
2.88 MHz	4.0	0.39 ns or less		170 ns to 177 ns	
4.5 MHz	6.2	0.36 ns or less		109 ns to 114 ns	
7.2 MHz	10.0	0.34 ns or less		67.2 ns to 71.6 ns	

## D-to-C Jitter Measurement and Phase Adjustment Test

### Items Required

The following items are required:

- **Synthesized signal generator**
  - Frequency range: 720 kHz to 25 MHz
  - Output level: 720 mVrms or more
  - Recommended instrument: Synthesized signal generator 8657B (Agilent Technologies)
- **Power divider**
  - Characteristic impedance: 50  $\Omega$
  - Recommended device: 700966 (YOKOGAWA)
- **50- $\Omega$  terminator**
  - Recommended device: 700976 (YOKOGAWA)



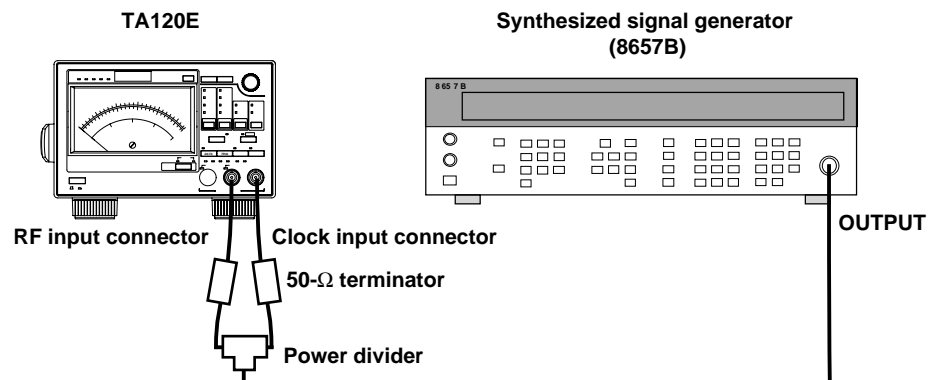

The procedure for testing the D-to-C jitter measurement and phase adjustment using the recommended instruments is described below.

### Connecting the Instrument

- Check that the power switch is turned OFF on all instruments before connecting them.
- Connect the output of the synthesized signal generator to the RF input connector of the TA120E through the power divider and 50- $\Omega$  terminators. The cables used to connect the power divider to the RF input and clock input connectors of the TA120E must be the same length.



### Instrument settings

- TA120E
  - Measurement function: D-to-C
  - Slope of the data signal: , 
  - Slope of the clock signal: , 
  - Gate: 0.1 s
  - Trigger mode: MAN
  - Slice level: 0.000 V
  - Phase difference: 5.0 ns, 10.0 ns, and 30.0 ns
- 8657B
  - Output level: 720 mVrms
  - Output frequency: 20 MHz



## 9.6 Executing the Performance Test

### Test method

- Test the TA120E after 30 minutes of warm-up.
- Set the slope and the phase difference of the TA120E signal to the values indicated in the table below and confirm that the standard deviation  $\sigma$  (jitter) under the D-to-C jitter measurement of the TA120E is within the allowable range in the table.

### Test procedure

1. Set the output level of the 8657B to 720 mVrms and the frequency to 20 MHz.
2. Set the slope of the data signal of the TA120E to  $\uparrow\downarrow$ , the slope of the clock signal to  $\uparrow$ , and the phase difference to [5.0ns].
3. Read the standard deviation  $\sigma$ . Confirm that the value is within the allowable range.
4. Set the slope of the data signal of the TA120E, the slope of the clock signal, and the phase difference according to the table below, then perform the test in a similar fashion.

### Test result

- **Slope of the data signal:  $\uparrow\downarrow$ , slope of the clock signal:  $\uparrow$**

Phase difference between the data signal and the clock signal	Standard Deviation $\sigma$ (Jitter)
---------------------------------------------------------------	--------------------------------------

	Measured Value	Allowable Range
5.0 ns		0.4 ns or less
10.0 ns		0.4 ns or less
30.0 ns		0.4 ns or less

- **Slope of the data signal:  $\uparrow\downarrow$ , slope of the clock signal:  $\downarrow$**

Phase difference between the data signal and the clock signal	Standard Deviation $\sigma$ (Jitter)
---------------------------------------------------------------	--------------------------------------

	Measured Value	Allowable Range
5.0 ns		0.4 ns or less
10.0 ns		0.4 ns or less
30.0 ns		0.4 ns or less

- **Slope of the data signal:  $\downarrow\uparrow$ , slope of the clock signal:  $\uparrow$**

Phase difference between the data signal and the clock signal	Standard Deviation $\sigma$ (Jitter)
---------------------------------------------------------------	--------------------------------------

	Measured Value	Allowable Range
5.0 ns		0.4 ns or less
10.0 ns		0.4 ns or less
30.0 ns		0.4 ns or less

- **Slope of the data signal:  $\downarrow\uparrow$ , slope of the clock signal:  $\downarrow$**

Phase difference between the data signal and the clock signal	Standard Deviation $\sigma$ (Jitter)
---------------------------------------------------------------	--------------------------------------

	Measured Value	Allowable Range
5.0 ns		0.4 ns or less
10.0 ns		0.4 ns or less
30.0 ns		0.4 ns or less

## Equalizer Test

### Items Required

The following items are required:

- **Synthesized signal generator**
  - Frequency range: 100 kHz to 10 MHz
  - Output level: 720 mVrms or more
  - Recommended instrument: Synthesized signal generator 8657B (Agilent Technologies)
- **50-Ω terminator**  
Recommended device: 700976 (YOKOGAWA)

The procedure for testing the equalizer using the recommended instrument is described below.

### Connecting the Instrument

- Check that the power switch is turned OFF on all instruments before connecting them.
- Connect the output of the synthesized signal generator to the RF input connector of the TA120E through the 50-Ω terminator.

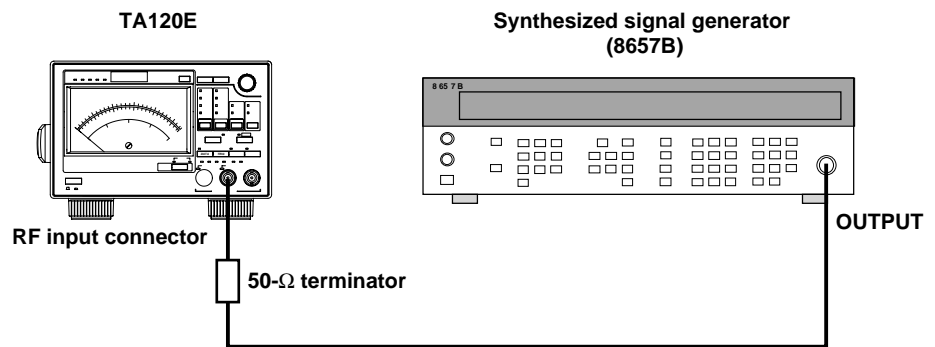

### Instrument settings

- TA120E  
Equalizer test mode in the maintenance mode  
(To enter the maintenance mode, turn ON the power while pressing the SCALE key. Hold the SCALE key down for approximately 3 seconds.)
- 8657B
  - Output level: 225 mVrms (approx. 0.63 V<sub>P-P</sub>)
  - Output frequency: 300 kHz, 5.16 MHz, and 10 MHz

## 9.6 Executing the Performance Test

---

### Test method

- Test the TA120E after 30 minutes of warm-up.
- Set the frequency of the 8657B to the values indicated in the table below. Determine the ratio of the amplitude for 5.16 MHz and 10 MHz with respect to the amplitude for 300 kHz with the TA120E set to the equalizer test mode within the maintenance mode. Confirm that the ratios are within the allowable range shown in the table below.
- This test is a simplified test. To accurately check the frequency characteristics of the equalizer, perform the test using a spectrum analyzer as described in section 8.7, "Adjusting the Equalizer."

### Test procedure

1. Set the output level of the 8657B to 225 mV<sub>rms</sub> and the frequency to 300 kHz.
2. Start up the TA120E in the maintenance mode and press the DATA key. The characters [EQLZ] appear on the display, and the TA120E enters the equalizer test mode.
3. Press the > key. The peak value of the amplitude is measured 10 times, and the average is shown on the display. Every time the > key is pressed the peak value is measured, and the average value is shown on the display.
4. Set the frequency of the 8657B to the values indicated in the table below, then perform the test in a similar fashion.
5. Press the < key. The TA120E returns to the maintenance mode.

### Test result

Frequency of the 8657B	Average (Measured Value) of the Peak Values (P-to-P)	Amplitude Ratio (Value to Be Checked)	Allowable Range
300 kHz	(A)	—	—
5.16 MHz	(B1)	(B1/A)	1.33 (2.5 dB) to 1.57 (3.9 dB)
10 MHz	(B2)	(B2/A)	1.0 (0 dB) or less

## Auto Slice Test

### Items Required

The following items are required:

#### Function generator

- Output amplitude resolution: 12 bits or more
- Memory length: 8192 points or more
- With arbitrary waveform generation function
- Recommended instrument: Synthesized function generator FG300 (YOKOGAWA)

The procedure for testing the auto slice using the recommended instrument is described below.

### Connecting the Instrument

- Check that the power switch is turned OFF on all instruments before connecting them.
- Connect the output of the function generator to the RF input connector of the TA120E.

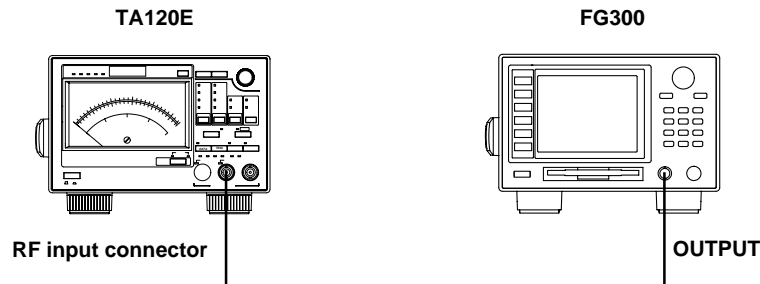

### Instrument settings

- TA120E
  - Measurement function: 3TCD( $\times N$ )
  - Polarity of the data signal:  $\uparrow\downarrow$ ,  $\downarrow\uparrow$
  - Speed (N): 6.2
  - Gate: 0.1 s
  - Trigger mode: MAN, AUTO
  - Slice level: 0.000 V
- FG300
  - Output frequency: 180.18 kHz
  - Output voltage amplitude: 6 V<sub>P-P</sub>
  - Phase: 0.0 deg
  - Offset voltage: 0.0 V
  - Output attenuator: 1/10
  - Output waveform: Arbitrary waveform A1
  - Arbitrary waveform data: Read SLICE.WVF into A1.  
(Arbitrary waveform data SLICE.WVF can be downloaded from the URL below.  
If you set the loaded SLICE.WVF to a frequency of 180.18 kHz, a waveform with a gradual rising slope with a duty cycle of approximately 40% and a frequency of 4.5 MHz is achieved.

<http://www.yokogawa.co.jp/Measurement/English/Bu/TA120E/>

## 9.6 Executing the Performance Test





### Test method

- Warm up the TA120E and FG300 for 30 minutes before the test.
- Set the frequency of the FG300 to 180.18 kHz and set the polarity of the data signal and the trigger mode of the TA120E according to the table below. Confirm that the standard deviation  $\sigma$  (jitter) under the 3T jitter measurement is within the allowable range in the table below. The average value is reference value.

### Test procedure

1. Load the arbitrary waveform data SLICE.WVF into the FG300. Set the output frequency to 180.18 kHz, the output voltage amplitude to 6 V<sub>P-P</sub>, the phase to 0.0 deg, the offset voltage to 0.0 V, and the output attenuator to 1/10.
2. Set the polarity of the data signal of the TA120E to  and the trigger mode to [MAN].
3. Set the TA120E in the statistical value debug mode, and read the standard deviation  $\sigma$ . Confirm that the value is within the allowable range. The average value is reference value.
4. Set the polarity of the data signal and the trigger mode of the TA120E according to the table below, then perform the test in a similar fashion.

### Test result

Polarity of the Data Signal	Trigger Mode	Standard Deviation $\sigma$ (Jitter)	Average Value
		Measured Value Allowable Range	Measured Value Reference Value
	MAN	5.0 ns or less	114 ns or more
	MAN	5.0 ns or less	108 ns or less
	AUTO	5.0 ns or less	108 ns to 114 ns
	AUTO	5.0 ns or less	108 ns to 114 ns

## PLL Test

### Items Required

The following items are required:

#### Function generator

- With arbitrary waveform generation function
- Recommended instrument: Synthesized function generator FG300 (YOKOGAWA)

The procedure for testing the PLL using the recommended instrument is described below.

### Connecting the Instrument

- Check that the power switch is turned OFF on all instruments before connecting them.
- Connect the output of the function generator to the RF input connector of the TA120E.

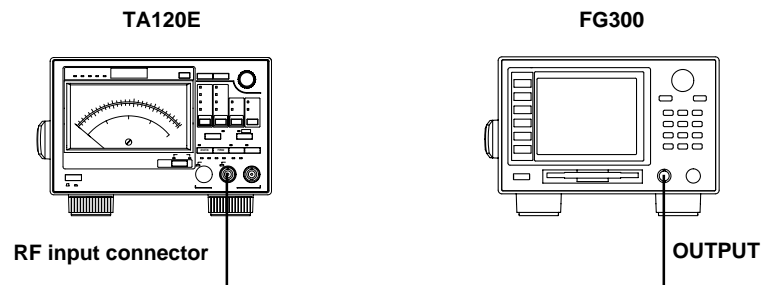

### Instrument settings

- TA120E
  - Measurement function: D-to-C
  - Polarity of the data signal: 
  - Gate: 0.1 s
  - Trigger mode: AUTO
  - PLL: ON
- FG300
  - Output frequency: 74.04665 kHz
  - Output voltage amplitude: 0.3 V<sub>P-P</sub>
  - Phase: 0.0 deg
  - Offset voltage: 0.0 V
  - Output attenuator: 1/1
  - Output waveform: Arbitrary waveform A2
  - Arbitrary waveform data: Read PLL.WVF into A2.  
(Arbitrary waveform data PLL.WVF can be downloaded from the following URL.  
If you set the loaded PLL.WVF to a frequency of 74.04665 kHz, a quasi-EFM signal is achieved.

<http://www.yokogawa.co.jp/Measurement/English/Bu/TA120E/>

## 9.6 Executing the Performance Test

---

### Test method

- Warm up the TA120E and FG300 for 30 minutes before the test.
- Set the frequency of the FG300 to 74.04665 kHz and confirm that the standard deviation  $\sigma$  (jitter) under the D-to-C jitter measurement of the TA120E is within the allowable range in the table. The average value is reference value.

### Test procedure

1. Load the arbitrary waveform data PLL.WVF into the FG300. Set the output frequency to 74.04665 kHz, the output voltage amplitude to 0.3 V<sub>P-P</sub>, the phase to 0.0 deg, the offset voltage to 0.0 V, and the output attenuator to 1/1.
2. Turn ON the PLL of the TA120E.
3. Set the TA120E in the statistical value debug mode, and read the standard deviation  $\sigma$ . Confirm that they are within the allowable range. The average value is reference value.

### Test result

Display	Standard Deviation $\sigma$ (Jitter)	Average Value
	Measured Value Allowable Range	Measured Value Reference Value
No [unLoC] display	5.0 ns or less	18 $\pm$ 5 ns

## 9.7 Adjusting the Equalizer

Perform the adjustment of the equalizer described in this section when the test results of the “Equalizer Test” in section 9.6, “Executing the Performance Test,” does not satisfy the allowable range.



### CAUTION

- Do not apply a voltage exceeding the maximum input voltage to the input terminal of each instrument. This may cause damage to the input section.
- Do not short the output terminals of instruments or apply external voltage to them. This may cause damage to the internal circuitry.

#### Items Required

The following items are required:

- **Spectrum analyzer**
  - Frequency range: 100 kHz to 10 MHz
  - Recommended instrument: MS2601 (Anritsu)
- **Synthesized signal generator**
  - Frequency range: 100 kHz to 10 MHz
  - Output level: 720 mVrms or more
  - Recommended instrument: Synthesized signal generator 8657B (Agilent Technologies)
- **50-Ω terminator**
  - Recommended device: 700976 (YOKOGAWA)

The procedure for adjusting the equalizer using the recommended instruments is described below.

#### Connecting the Instrument

- Check that the power switch is turned OFF on all instruments before connecting them.
- Connect the output of the synthesized signal generator to the RF input connector of the TA120E through the 50-Ω terminator.
- Connect the output of the monitor output connector (EQUALIZED RF/MONITOR OUT) of the TA120E to the spectrum analyzer.

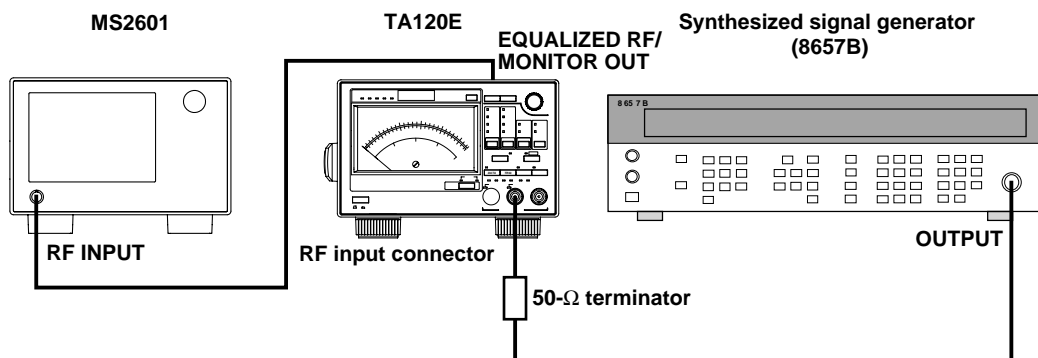



## 9.7 Adjusting the Equalizer

### Instrument settings

- TA120E  
Equalizer test mode in the maintenance mode  
(To enter the maintenance mode, turn ON the power while pressing the SCALE key. Hold the SCALE key down for approximately 3 s.)
- 8657B
  - Output level: 225 mV<sub>rms</sub> (approx. 0.63 V<sub>P-P</sub>)
  - Output frequency: 300 kHz, 5.16 MHz
- MS2601
  - Sweep time: AUTO
  - Attenuator: AUTO
  - Resolution bandwidth: Auto
  - Span: 2 kHz
  - Reference level: -20 dbm

### Adjustment procedure

1. Adjust the TA120E after 30 minutes of warm-up.
2. Set the output frequency of the 8657B to 300 kHz, and the center frequency of the MS2601 to 300 kHz.
3. Set the center frequency to the frequency of the peak value that is actually measured on the MS2601 at 300 kHz. Consider the peak value at this point to be A.
4. Set the output frequency of the 8657B to 5.16 MHz, and the center frequency of the MS2601 to 5.16 MHz.
5. Set the center frequency to the frequency of the peak value that is actually measured on the MS2601 at 5.16 MHz. Consider the peak value at this point to be B.
6. Turn the equalizer adjustment trimmer  $\odot$  (EQLZ ADJUST) on the rear panel of the TA120E using a flat-head screwdriver and adjust the B value so that B - A is within  $3.2 \pm 0.1$  dB.

The equalizer adjustment trimmer  $\odot$  is located inside the case. Insert a flat-head screwdriver into the EQLZ ADJUST hole on the rear panel and turn the adjustment trimmer  $\odot$ .

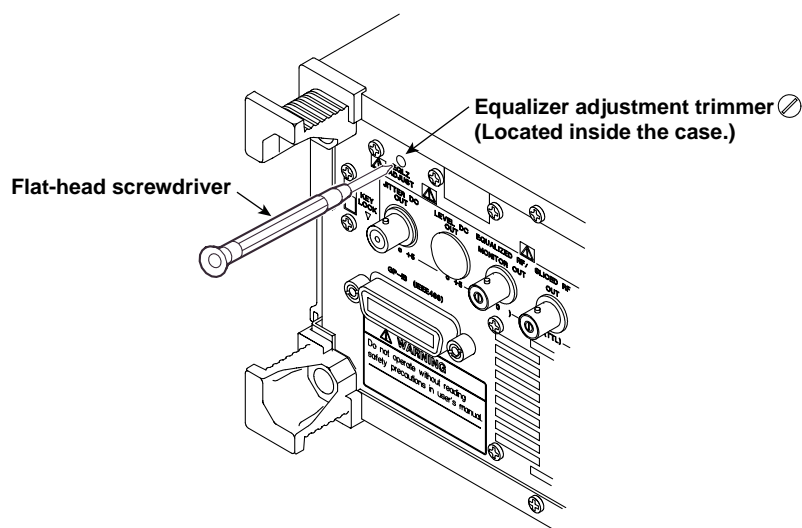

## 9.8 Circuit Breaker



### CAUTION

When the circuit breaker trips and shuts off the power, a problem may have occurred in the internal circuit. If the reset button does not return to the original position, do not reset it numerous times. Instead, contact your nearest YOKOGAWA dealer as listed on the back cover of this manual.

#### Position of the circuit breaker

Instead of a power fuse, a circuit breaker that protects the internal circuit is provided on the rear panel. For the position of the circuit breaker, see section 2.2.

#### Circuit breaker operation

If the TA120E becomes overloaded and over current flows through the internal circuits, the power is shut off. When the power is shut off, the reset button pops out (see figure below) and the white indicator section becomes exposed.

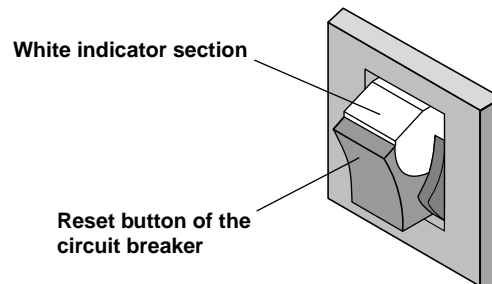

#### Resetting the circuit breaker









If the circuit breaker trips and shuts off the power, you can recover the original condition by pressing in the reset button after waiting at least one minute. However, if the overloaded condition continues, the trip-free mechanism is enabled and the reset button does not return to the original position.

## 9.9 Recommended Replacement Parts

The one-year warranty applies only to the main unit of the instrument (starting from the day of delivery) and covers neither consumable items (items which wear out), nor any other items. The replacement period for expendable items varies depending on the conditions of use. Refer to the table below as a general guideline. Contact your nearest YOKOGAWA dealer for replacement parts.

<b>Parts Name</b>	<b>Specifications and Recommended Replacement Period</b>
Equalizer relay	Relay that operates on the ON/OFF condition of the equalizer. <ul style="list-style-type: none"><li>• Electric switching life: Approx. 1,000,000 times (at an input voltage of less than or equal to <math>\pm 1</math> V).</li><li>• Mechanical life: Approx. 100,000,000 times.</li></ul>
Backup battery (Lithium battery)	5 years
Meter	10 years

# 10.1 Signal Input and Trigger

Item	Specification
Number of channels	2 (1 RF input connector and 1 clock input connector)
Maximum sample rate	During D-to-C jitter measurement: 10 MS/s (100 ns interval) continuous During 3T jitter measurement: 5 MS/s (200 ns interval) continuous
Internal jitter* <sup>1</sup> , * <sup>2</sup>	During D-to-C jitter measurement: 400 psrms, during 3T jitter measurement: 300 psrms
<b>RF input</b>	
Connector type	BNC
Coupling	DC (AC coupling when the equalizer is ON or when the trigger mode is set to auto mode or auto + manual mode.)
Input impedance	1 MΩ, 35 pF (typical value* <sup>3</sup> )
Minimum input pulse width	15 ns
Maximum input voltage	DC ≤ frequency of the input signal ≤ 100 kHz: 40 V (DC±ACpeak) 100 kHz ≤ frequency of the input signal ≤ 100 MHz: {3.5/f + 5} V (DC+ACpeak), where f is a frequency in MHz.
Input sensitivity* <sup>1</sup>	100 mV <sub>P-P</sub> (200 mV <sub>P-P</sub> when the equalizer is ON)
Input range	When the trigger mode is set to manual mode and the equalizer is OFF: -5 V to 5 V When the trigger mode is set to auto mode or auto + manual mode or when the equalizer is ON: -1 V to 1 V
Trigger	Trigger mode Select from auto mode, manual mode, and auto + manual mode. Trigger slope During D-to-C jitter measurement: Select from  ,  , and  &  . During 3T jitter measurement: Select from  and  . Selectable range When the trigger mode is set to manual mode and the equalizer is OFF: -5.000 V to 5.000 V When the trigger mode is set to manual mode and the equalizer is ON: -1.000 to 1.000 Resolution When the trigger mode is set to manual mode: 1 mV When the trigger mode is set to auto + manual mode: 0.001 (equivalent to approx. 1 mV) Accuracy* <sup>1</sup> (when the trigger mode is set to manual mode): ±(4% of the specified value + 10 mV)
<b>Clock input</b>	
Connector type	BNC
Coupling	AC
Input impedance	1 MΩ, 35 pF (typical value* <sup>3</sup> )
Maximum input voltage	DC ≤ frequency of the input signal ≤ 100 kHz: 40 V (DC±ACpeak) 100 kHz ≤ frequency of the input signal ≤ 100 MHz: {3.5/f + 5} V (DC+ACpeak), where f is a frequency in MHz.
Input sensitivity* <sup>1</sup>	100 mV <sub>P-P</sub>
Input range	-5 V to 5 V
Input frequency range	25 MHz to 60 MHz
Duty	45% to 55%
Trigger	Trigger level: Fixed to 0 V. Trigger slope: Select  or  .
Phase difference (amount of delay) adjustment* <sup>4</sup>	Range: 0.0 ns to 40.0 ns Resolution: 0.1 ns
<b>Equalizer</b>	
Frequency characteristics* <sup>1</sup> , * <sup>5</sup>	3.2±0.3 dB (the ratio of the amplitude at 5.16 MHz with respect to the amplitude at 300 kHz.) (The amount of boost of the equalizer is variable.)
Group delay characteristics	Maximum group delay deviation: 6 ns (typical value* <sup>3</sup> ), range: 0.7 MHz ≤ f ≤ 6.7 MHz
Signal that can be regenerated by the PLL clock* <sup>1</sup>	8-16 modulation signal with the reference clock corresponding to 27 MHz±10%.

\*<sup>1</sup> Measured value under standard operating conditions as described in General Specifications after the warm-up time has elapsed.

\*<sup>2</sup> Value obtained with the equalizer turned OFF and with the trigger error and trigger level timing error excluded.

- Trigger error

$$\frac{\sqrt{X^2 + E_n^2}}{\text{S.R.}}$$

X: Signal noise (400 μV<sub>rms</sub>) within the input amplifier bandwidth (100 MHz)  
E<sub>n</sub>: Noise in the signal being measured  
S.R.: Slew rate of the signal being measured

- Trigger level timing error

$$\pm \left( \frac{15\text{mV}}{\text{Slew rate of the start signal}} - \frac{15\text{mV}}{\text{Slew rate of the stop signal}} \right) \pm \frac{\text{Trigger level setting accuracy}}{\text{Slew rate of the start signal}} \pm \frac{\text{Trigger level setting accuracy}}{\text{Slew rate of the stop signal}}$$

\*<sup>3</sup> The typical value is a representative or standard value. It is not strictly guaranteed.

\*<sup>4</sup> Phase difference (amount of delay) adjustment is only allowed on the clock signal that is applied to the clock input connector. It cannot be applied to the clock signal that is regenerated by the built-in PLL circuit.





\*<sup>5</sup> If the frequency characteristics of the equalizer is tested using the peak value measurement function of the TA120E as described in "Equalizer Test" in section 9.6, "Executing the Performance Test," the value is 3.2 ± 0.7 dB.

## 10.2 Measurement Function

Item	Specification
Measurement update rate*1	50 ms minimum (when measuring a 8-16 modulated signal with the measurement function set to D-to-C jitter, slope of the data signal set to both rising and falling, and the gate type set to event gate (number of acquisitions of measured values fixed to 10 <sup>5</sup> ))
D-to-C jitter (time difference between the data signal and clock signal of a DVD)	Measurement range: -5 ns to T + 5 ns, where T is the period of the measured clock signal Statistics display: Select from jitter ratio, jitter, and average value
3T jitter (pulse width of the 3T data signal of a CD)	Speed: Select from ×1 and ×N. Manual setting of speed (only when set to ×N) is possible. <ul style="list-style-type: none"> <li>• Range: 1.0 to 10.0</li> <li>• Resolution: 0.1</li> </ul> Measurement range: 2.5T to 3.5T (where T = 231.385 ns/N and N is the speed) Statistics display: Select from jitter ratio, jitter, and average value
Average value*1	Accuracy: ±(300 psrms + trigger level timing error + (time base frequency stability x measured value) + 1 ns systematic error) (when the measurement function is set to 3T)

\*1 Measured value under standard operating conditions as described in General Specifications after the warm-up time has elapsed.

## 10.3 Gate, Arming, and Inhibit

Item	Specification
Gate	
Gate type	Select event gate (number of acquisitions of measured values fixed to 10 <sup>5</sup> ) or time gate (0.1 s, 0.5 s, or manual).
Gate time (only for manual setting)	Range: 1.0 ms to 1000.0 ms Resolution: 0.1 ms
Arming	
Arming source	Internal arming The internal signal of the TA120E becomes the arming source. External arming The external signal applied to the external arming input connector (EXT ARM IN) becomes the arming source. For the specifications of the input connector, see section 10.6.
Arming slope (only during external arming)	Select  or  .
Arming delay (only during external arming)	Range: 0.0 ms to 1000.0 ms Resolution: 0.1 ms
Inhibit	The external signal applied to the inhibit input connector (INHIBIT IN) becomes the inhibit signal. For the specifications of the input connector, see section 10.6. Polarity: Select  or  .

## 10.4 Display

Item	Specification
Display type	Meter (needle) 7-segment LED display (Function to turn ON/OFF the display of the measured results available.)
Unit	Meter: % Display: % (jitter ratio) or ns (jitter and average value).
Meter scale	Select 10% or 20% for the full scale (FS).
Indication accuracy of the meter	$\pm 1.5\%$ of FS
Resolution of the display	For % unit: 0.01% For ns unit: 0.01 ns

## 10.5 Time Base

Item	Specification
Internal reference frequency clock	50 MHz
Frequency stability	100 ppm
Aging	$\pm 5$ ppm/year

## 10.6 Input/Output on the Rear Panel

Item	Specification
<b>External arming input (EXT ARM IN)</b>	
Connector type	BNC
Input impedance	10 k $\Omega$ (typical value <sup>*1</sup> )
Input coupling	DC
Input level	TTL level
Allowable input voltage range	-8 V to 13 V (DC+ACpeak)
Minimum pulse width	30 ns
Setup time	0 ns (possible even when the external arming and data signals are simultaneous.)
<b>Inhibit input (INHIBIT IN)</b>	
Connector type	BNC
Input impedance	10 k $\Omega$ (typical value <sup>*1</sup> )
Input coupling	DC
Input level	TTL level
Allowable input voltage range	-8 V to 13 V (DC+ACpeak)
Minimum pulse width	30 ns
Setup time	0 ns (possible even when the inhibit signal and data signal are simultaneous.)
<b>Jitter DC output (DC OUT)</b>	
Connector type	BNC
Output impedance	50 $\Omega$ (typical value <sup>*1</sup> )
Output coupling	DC
Output mode	Select jitter ratio output or determination output.
Output filter	Range of average coefficient: 1 to 10
Jitter ratio output range	Range: 0.00% to 100.00%, resolution: 0.01%
Determination output	Range of determination level: 0.00% to 100.00%, resolution: 0.01%
Correction coefficient	Correction coefficient $\alpha$ Range: 0.0001 to 9.9999, resolution: 0.0001 Correction coefficient $\beta$ Range: -9.999 to 9.999%, resolution: 0.001%
Output level <sup>*2</sup>	0 V to 5 VDC
Output level accuracy <sup>*2, *3</sup>	$\pm 10$ mV
<b>Monitor output of the RF signal (MONITOR OUT) and monitor output of the equalized RF signal (EQUALIZED RF).</b> Shares one connector.	
Connector type	BNC
Output impedance	50 $\Omega$ (typical value <sup>*1</sup> )
Output coupling	DC
Output level <sup>*4</sup>	When the equalizer is OFF <ul style="list-style-type: none"> <li>Approximately 1/4 the RF signal (within <math>\pm 5</math> V) when the trigger mode is set to manual mode.</li> <li>Approximately 4/5 the RF signal (within <math>\pm 5</math> V) when the trigger mode is set to auto or auto + manual mode.</li> </ul> When the equalizer is ON Approx. $\pm 0.5$ V
<b>Data signal output (SLICED RF OUT)</b>	
Connector type	BNC
Output impedance	50 $\Omega$ (typical value <sup>*1</sup> )
Output coupling	DC
Output level <sup>*2</sup>	TTL level
<b>Clock signal output (CLOCK OUT)</b>	
Connector type	BNC
Output impedance	50 $\Omega$ (typical value <sup>*1</sup> )
Output coupling	DC
Output level <sup>*2</sup>	TTL level

\*1 The typical value is a representative or standard value. It is not strictly guaranteed.

\*2 When the monitor equipment receives the signal at high impedance (approx. 1 M $\Omega$ ).

\*3 Measured value under standard operating conditions as described in General Specifications after the warm-up time has elapsed.

\*4 When the monitor equipment receives the signal at 50  $\Omega$ .

## 10.7 GP-IB Interface

Item	Specification
Electrical and mechanical specifications	Conforms to IEEE St'd.488-1978 (JIS C1901-1987).
Functional specifications	SH1, AH1, T6, L4, SR1, RL1, PP0, DC1, DT1, and C0
Protocol	Conforms to IEEE St'd.488.2-1992.
Code	ISO (ASCII) code
Mode	Addressable mode
Address	0 to 30
Clear remote mode	Remote mode can be cleared using the LOCAL key (except during Local Lockout).



## 10.8 General Specifications

Item	Specification
Standard operating conditions	
Ambient temperature	23±5°C
Ambient humidity	50±10% RH
Error in supply voltage and frequency	Within 1% of rating
Warm-up time	Approx. 30 minutes.
Storage conditions	
Temperature	-20°C to 60°C
Humidity	20% to 80% RH (no condensation)
Operating conditions	
Temperature	5°C to 40°C
Humidity	20% to 80%RH (no condensation)
Rated supply voltage	100 V to 240 VAC
Permitted supply voltage range	90 V to 264 VAC
Rated supply voltage frequency	50/60 Hz
Permitted supply voltage frequency range	48 Hz to 63 Hz
Maximum power consumption	100 VA
Insulation resistance (between power supply and case)	10 MΩ or more (500 VDC)
Withstanding voltage (between power supply and case)	1500 VAC at 50/60 Hz for one minute
Signal ground	The ground of all input and output connectors are connected to the case ground. In addition, all input terminals are protected using a diode.
Dimensions	Approx. 213(W) × 132(H) × 350 (D) mm excluding projections.
Weight	Approx. 5 kg (main unit only)
Cooling method	Forced air cooling
Installation position	Horizontal (stacking prohibited)
Battery backup	Setup information is backed up with the internal lithium battery
Key lock	Able to set key lock.
Standard Accessories	
Power cord	1 piece
Rubber feet	1 set (2 pieces)
User's manual	1 piece (this manual)
Safety standard	Complying standard EN61010-1 Overvoltage Category (Installation Category)II <sup>*1</sup> Pollution degree 2 <sup>*2</sup>
Emission	Complying standard EN55011-Group 1 Class A This is Class A product(for industrial environment). In a domestic environment this product may cause radio interference in which case the user may be required to take adequate measures. EN61000-3-2      Harmonics current EN61000-3-3      Flicker and voltage fluctuations
Immunity	Complying standard EN61326      Industrial locations • Cabels condition The applied BNC cable, GP-IB cable and EXT I/O cable must be shorter than 3 meters.

\*1 Overvoltage Categories define transient overvoltage levels, including impulse withstand voltage levels.  
Overvoltage Category I: Applies to equipment supplied with electricity from a circuit containing an overvoltage control device.

Overvoltage Category II: Applies to equipment supplied with electricity from fixed installations like a distribution board.

\*2 Pollution Degree: Applies to the degree of adhesion of a solid, liquid, or gas which deteriorates withstand voltage or surface resistivity,

Pollution Degree 1: Applies to closed atmospheres (with no, or only dry, non-conductive pollution).

Pollution Degree 2: Applies to normal indoor atmospheres (with only non-conductive pollution).

# 10.9 Dimensional Drawings

Unit: mm

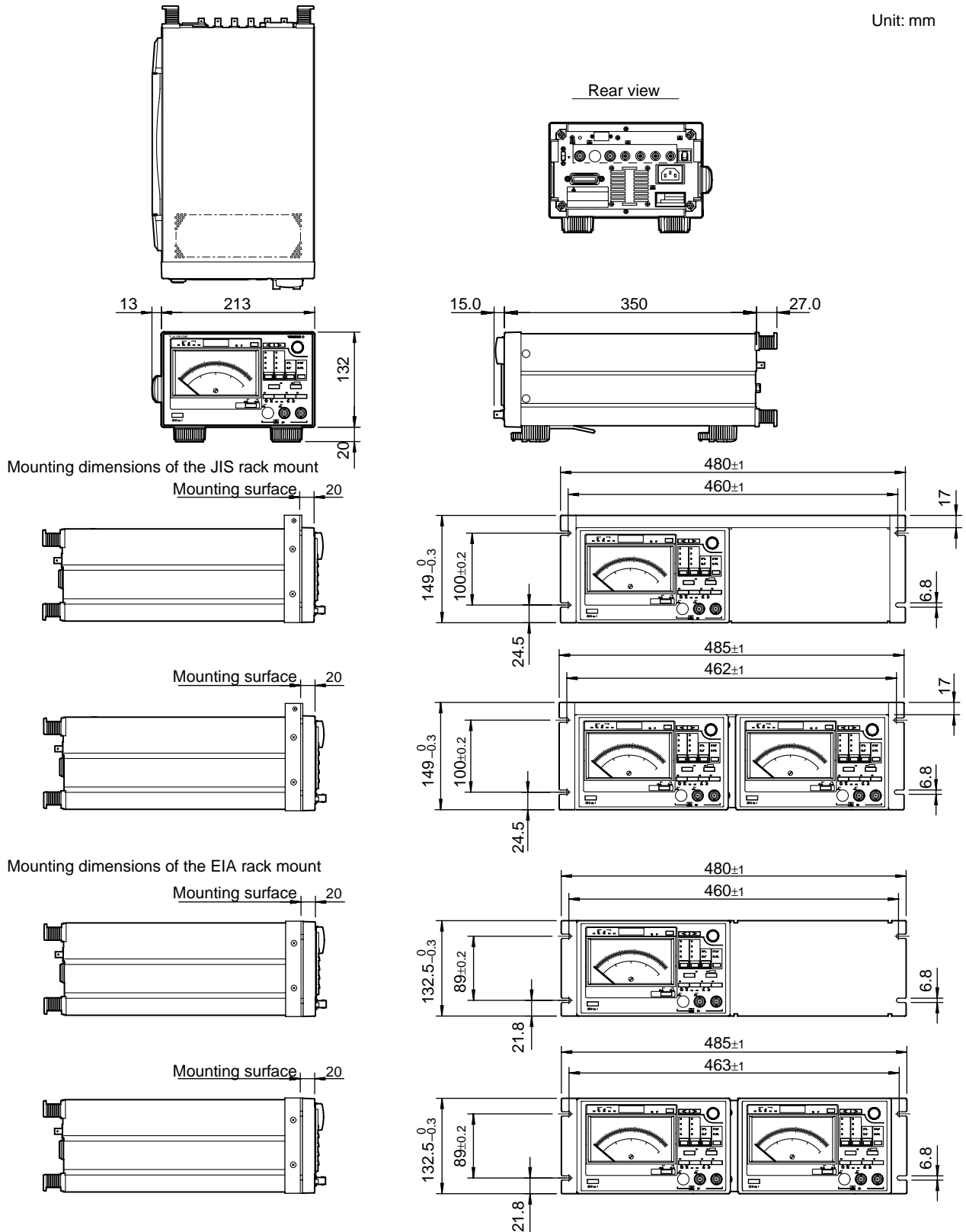

Caution: Make sure to have adequate support for the bottom of the instrument. Allow at least 80 mm of space around the instrument for ventilation.

If not specified, the tolerance is ±3%. However, in cases of less than 10 mm, the tolerance is ±0.3 mm.

# Index

## Symbols

×N speed .....	1-5, 4-2
3T jitter .....	1-5, 4-2

## A

adjusting the phase difference .....	1-11
adjusting the zero position of the needle .....	1-14
adjustment trimmer .....	2-1
ALPHA .....	7-2
ARM key .....	2-1
arming .....	1-9, 4-10
arming delay .....	1-9, 4-10
arrow (< and >) keys .....	2-1
ASCII character code .....	8-54
AUTO .....	4-6
auto + manual mode .....	1-8, 4-6
auto arming .....	1-9, 4-10
auto mode .....	1-8, 4-6
auto slice .....	1-7
AVE .....	7-2
average coefficient .....	7-4
average value .....	8-19

## B

backing up setup information .....	1-14
Backus-Naur Form .....	8-7
bEtA .....	7-2
binarization of the RF signal .....	1-7
binary data .....	8-26
bit masking .....	8-37, 8-38
block diagram .....	1-2
BNF symbol .....	8-7
board test .....	9-8
boolean .....	8-12

## C

calibrated item .....	9-11
calibration .....	1-14
character data .....	8-12
character string data .....	8-13
circuit breaker .....	2-2
CLOCK key .....	2-1
clock signal .....	4-14
clock signal input .....	1-11
clock signal output .....	1-13
clock signal output connector .....	2-2
command .....	8-15
common command header .....	8-9
communication .....	1-14
compound header .....	8-9
condition register .....	8-39
conventions used in this manual .....	vii
correction coefficient .....	7-5

## D

D-to-C jitter .....	1-6, 4-2
data .....	8-11
DATA key .....	2-1
data signal output .....	1-13
data signal output connector .....	2-2
dc hi .....	7-1
dc Lo .....	7-1
DC output .....	1-13
DC output connector .....	2-2
DC output filter .....	1-13
DC output mode .....	7-3
dcJdG .....	7-2
dcout .....	7-1
deadlock .....	8-9
decimal .....	8-11
detection of a cooling fan malfunction .....	1-14
determination level .....	7-4
determination output .....	7-3
digital number and character .....	viii
display .....	2-1
displaying jitter, jitter ratio and average value .....	5-3
done .....	7-9

## E

effect length error .....	8-19
ELError .....	8-19
enable register .....	8-37
equalizer adjustment trimmer .....	2-2
equalizing of RF signal .....	1-7
error code .....	9-2
error message .....	9-2
error queue .....	8-40
event gate .....	1-9, 4-8
extended event register .....	8-39
external arming .....	1-9, 4-10
external arming input connector .....	2-2
external arming signal .....	4-10

## F

F-VEr .....	7-11
factory default calibration value .....	9-11
flutter .....	8-19
fractional pulse .....	1-4
fractional time .....	1-4
front panel .....	2-1
FUNC key .....	2-1

## G

gate .....	1-9, 4-8
GATE key .....	2-1
gate time .....	4-8
general handling precaution .....	3-2
general specifications .....	10-6
GP-IB address .....	8-5
GP-IB connector .....	2-2
GP-IB interface .....	10-5
GP-IB interface function .....	8-3
GP-IB interface specification .....	8-3

## Index

### H

handle ..... 2-1  
header interpretation rule ..... 8-10

### I

indicating the jitter ratio ..... 5-1  
indicator test ..... 9-8  
INH key ..... 2-1  
inhibit ..... 1-10  
inhibit input connector ..... 2-2  
inhibit signal ..... 4-12  
initialization ..... 7-9  
initializing setup information ..... 1-14  
input/output on the rear panel ..... 10-4  
installation condition ..... 3-3  
installation position ..... 3-5  
instrument number ..... ii  
interface message ..... 8-6  
internal arming ..... 1-9, 4-10

### J

Jitt ..... 7-1  
jitter ratio ..... 1-5, 1-6, 8-19  
jitter ratio correction coefficient ..... 7-5  
jitter ratio determination ..... 1-13  
jitter ratio indication ..... 1-12, 5-1  
jitter ratio output ..... 7-3  
jitter ratio output range ..... 7-4  
JudGE ..... 7-1

### K

key and rotary knob test ..... 9-8  
key lock ..... 1-14, 7-12  
KEY LOCK indicator ..... 2-1  
KEY LOCK switch ..... 2-2

### L

list of commands ..... 8-15  
listener function ..... 8-3  
LOCAL key ..... 2-1  
local mode ..... 8-3

### M

maintenance mode ..... 9-6  
MAN ..... 4-6  
manual mode ..... 1-8, 4-6  
maximum effect length error ..... 8-19  
maximum value ..... 8-19  
MEAS key ..... 2-1  
measurement function ..... 1-5  
measurement indicator ..... 2-1  
measurement item ..... 1-5  
measurement principle ..... 1-4  
MELE ..... 8-19  
MEMory Group ..... 8-26  
message ..... 8-7  
meter ..... 2-1  
meter display ..... 1-12  
meter test ..... 9-8  
minimum value ..... 8-19  
MODEL ..... ii

monitor output ..... 1-13, 7-6  
monitor output connector ..... 2-2  
multi-line message ..... 8-6  
multiplier ..... 8-12

### N

name of part ..... 2-1  
name plate ..... 2-2  
number of data ..... 8-27  
numeric display ..... 1-12, 5-3

### O

ON/OFF the numerical display ..... 5-3  
optional accessory ..... iii  
output queue ..... 8-40

### P

peak-to-peak ..... 8-19  
period of the clock signal ..... 8-19  
phase correcting the probe ..... 3-9  
phase difference ..... 1-11, 4-15  
phase difference indication ..... 1-12  
PHASE key ..... 2-1  
PMT ..... 8-8  
polarity of the data signal ..... 4-2  
position of the data ..... 8-27  
power connector ..... 2-2  
power cord ..... iii  
power switch ..... 2-1  
power up operation ..... 3-7  
program data ..... 8-8  
program header ..... 8-8  
program message ..... 8-7  
PrStx ..... 6-2

### Q

queue ..... 8-37

### R

rack mount ..... 3-5  
rear panel ..... 2-2  
rECAL ..... 6-2  
recalling ..... 6-2  
regenerated clock signal ..... 4-14  
regenerating the clock signal ..... 1-11  
register ..... 8-12, 8-37  
remote indicator ..... 2-1  
remote mode ..... 8-3  
response ..... 8-11  
response data ..... 8-8  
response header ..... 8-8  
response message ..... 8-8  
responses to interface message ..... 8-6  
RF signal input indicator ..... 2-1  
RMT ..... 8-8  
ROM version ..... 7-11  
rotary knob ..... 2-1

**S**

safety precaution .....	iv, 3-1
sample program .....	8-41
scale .....	5-1
SCALE key .....	2-1
selecting 3T jitter .....	4-2
selecting D-to-C jitter .....	4-2
self-test .....	1-14
setting the numerical value .....	3-11
setup indicator .....	2-1
SHIFT key .....	2-1
shutdown operation .....	3-7
signal flow .....	1-2
signal input .....	10-1
signal input connector .....	2-1
simple header .....	8-9
slice level .....	1-7, 1-8, 4-6
slope of the clock signal .....	4-3
slope of the data signal .....	4-2
speed .....	1-5
standard accessory .....	iii
standard deviation .....	8-19
standard event register .....	8-38
status byte .....	8-37
status report .....	8-36
storage location .....	3-4
StorE .....	6-1
storing .....	6-1
SUFFIX code .....	ii
symbol .....	vii
synchronization using sequential command .....	8-13
system configuration .....	1-1

**T**

talker function .....	8-3
time gate .....	1-9, 4-8
transition filter .....	8-39
TRIG key .....	2-1
trigger .....	10-1
trigger error .....	10-1
trigger level timing error .....	10-1
trigger mode .....	1-8, 4-6

**U**

uni-line message .....	8-6
unit .....	8-12
unit indicator .....	2-1
upper-level query .....	8-10
URL .....	9-23

**V**

vent hole .....	2-2
version information .....	7-11

**W**

warning and caution plate .....	2-2
---------------------------------	-----

**X**

XCAL command .....	9-12
--------------------	------